

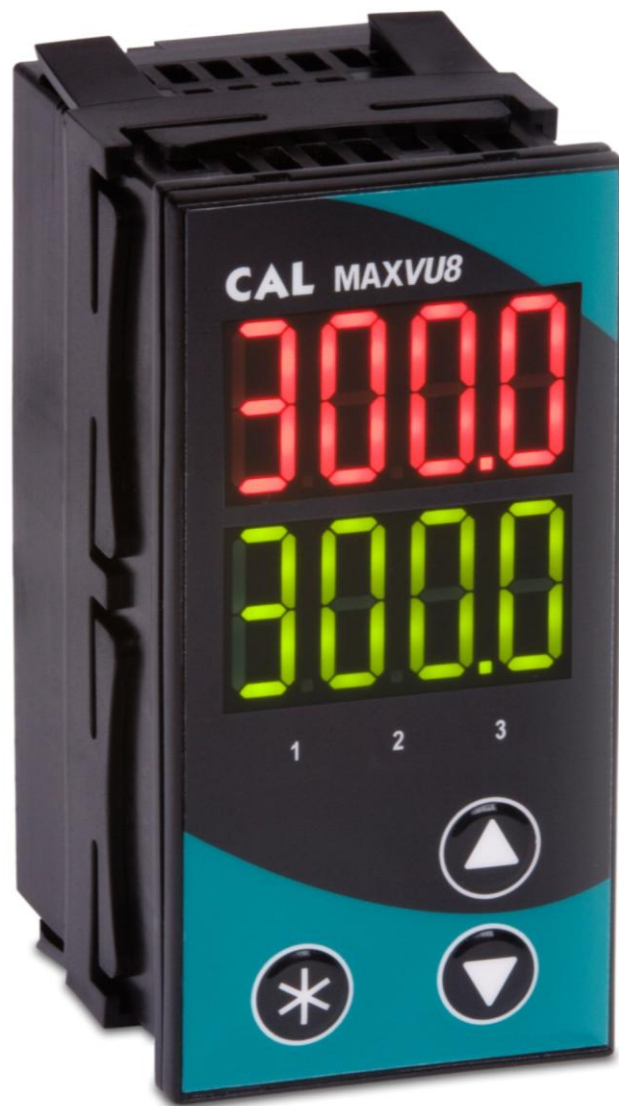

MaxVU Full Manual





This manual supplements the Concise Product manual supplied with each instrument at the time of shipment. Information in this installation, wiring and operation manual is subject to change without notice.

Copyright © November 2015, Danaher Corporation, all rights reserved. No part of this publication may be reproduced, transmitted, transcribed or stored in a retrieval system, or translated into any language in any form by any means without the written permission of Danaher / West Control Solutions.
Copies of this manual are available in electronic format on the West Control Solutions web site (www.west-cs.com).



WARNING: THE INTERNATIONAL HAZARD SYMBOL IS INSCRIBED ADJACENT TO THE REAR CONNECTION TERMINALS.



IT IS IMPORTANT TO READ THIS MANUAL BEFORE INSTALLING OR COMMISSIONING THE UNIT.

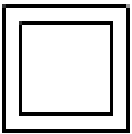

WARNING: THIS SYMBOL MEANS THE EQUIPMENT IS PROTECTED THROUGHOUT BY DOUBLE INSULATION.



WARNING: PRODUCTS COVERED BY THIS MANUAL ARE SUITABLE FOR INDOOR USE, INSTALLATION CATEGORY II, POLLUTION CATEGORY 2 ENVIRONMENTS.



Note: *It is strongly recommended that applications incorporate a high or low limit protective device, which will shut down the equipment at a pre-set process condition in order to prevent possible damage to property or products.*

Warranty and Returns Statement

This information is to be used with the published Terms and Conditions. These products are sold by West Control Solutions under the warranties set forth in the following paragraphs. Such warranties are extended only with respect to a purchase of these products, as new merchandise, directly from West Control Solutions or from a West Control Solutions distributor, representative or reseller and are extended only to the first buyer thereof who purchases them other than for the purpose of resale.

Warranty

These products are warranted to be free from functional defects in material and workmanship for three years from the time the products leave West Control Solutions factory and to conform at that time to the specifications set forth in the relevant West instruction manuals sheet or sheets.

THERE ARE NO EXPRESSED OR IMPLIED WARRANTIES, WHICH EXTEND BEYOND THE WARRANTIES HEREIN AND ABOVE SET FORTH. NO WARRANTY IS MADE OF MERCHANTABILITY OR FITNESS FOR A PARTICULAR PURPOSE WITH RESPECT TO THE PRODUCTS.

Limitations

West Control Solutions shall not be liable for any incidental damages, consequential damages, special damages, or any other damages, costs or expenses excepting only the cost or expense of repair or replacement as described above. Products must be installed and maintained in accordance with West Control Solutions instructions. There is no warranty against damage to the product resulting from corrosion. Users are responsible for the suitability of the products to their application.

For a valid warranty claim, the product must be returned carriage paid to the supplier within the warranty period. The product must be properly packaged to avoid damage from electro-static discharge (ESD) or other forms of harm during transit.

Contents

Warranty and Returns Statementiv

1 Installation8

1.1 Unpacking 8

1.2 Installation 8

1.3 Panel Cut-outs 8

1.4 Cleaning 9

2 Electrical Installation 10

2.1 Installation Considerations 10

2.2 AC Power Wiring - Neutral (for 100 to 240V AC versions) 10

2.3 Wire Isolation 10

2.4 Use of Shielded Cable 11

2.5 Noise Suppression at Source 11

2.6 Sensor Placement (Thermocouple or RTD) 12

2.7 Rear Panel Wiring 13

3 Powering Up 14

3.1 Powering Up Procedure 14

3.2 Auto-Tune 14

3.3 Front Panel 15

3.4 General Navigation 15

3.5 Device Configuration 15

3.6 Mode (or Menu) Structure 16

3.7 Returning to User Mode 16

3.8 Mode Access and Lock Codes 16

3.9 Use of the Controller for Non-Temperature Applications 17

3.10 Warnings and Error Messages 17

4 Setup Mode (First Power-Up) 18

5 User Mode 20

5.1 Basic Setpoint Control - Disabled 20

5.2 Basic Setpoint Control - Enabled 21

5.3 Comparing Basic Setpoint Control Enabled with Disabled 21

6 Advanced Configuration Mode (Adv) 22

6.1 User sub-menu (USER) 23

6.2 Input sub-menu (InPt) 23

6.3 Calibration sub-menu (CAL) 24

6.4 Output sub-menu (OUTP) 25

6.5 Control sub-menu (CONT) 26

6.6 Setpoint sub-menu (SPt) 28

Standard Controller Setpoint 28

6.7 Alarm sub-menu (ALrT) 29

| | | |
|-----------|---|-----------|
| 6.8 | Comms sub-menu (C <small>o</small> m <small>m</small> s) | 29 |
| 6.9 | Display sub-menu (d <small>i</small> s <small>p</small>) | 30 |
| 6.10 | Operator sub-menu (O <small>P</small> er) | 30 |
| 6.11 | Info sub-menu (I <small>n</small> F <small>o</small>) | 30 |
| 7 | “Extrusion” Version Controller sub-menus | 31 |
| 7.1 | Output sub-menu (O <small>U</small> T <small>P</small>) “Extrusion” version | 31 |
| 7.2 | Control sub-menu (C <small>O</small> n <small>t</small>) “Extrusion” version | 31 |
| 7.3 | Setpoint Sub-menu (S <small>P</small>) “Extrusion” version | 33 |
| 7.4 | Alarm sub-menu (A <small>L</small> r <small>⌋</small>) “Extrusion” version | 33 |
| 7.5 | Soft Start feature (“Extrusion” version) | 34 |
| 7.6 | Non-linear Cooling feature (“Extrusion” version) | 34 |
| 8 | Manually Tuning Controllers | 35 |
| 8.1 | Single Control Tuning (PID with Heat Output only) | 35 |
| 8.2 | Manually Tuning PID | 36 |
| | Dual Control Tuning (PID with Heat and Cool Outputs) | 36 |
| 8.3 | Manually Fine Tuning | 37 |
| 9 | Calibration Mode | 38 |
| 9.1 | Single point calibration (PV Offset) | 38 |
| 9.2 | Two Point Calibration | 39 |
| 10 | Serial Communications | 40 |
| 10.1 | Supported Protocol | 40 |
| 10.2 | RS485 Configuration | 40 |
| 10.3 | RS485 Device Addressing | 40 |
| 10.4 | Link Layer | 41 |
| 10.5 | Supported Modbus Functions | 42 |
| 10.6 | Function Descriptions | 42 |
| 11 | Modbus Addresses | 43 |
| 11.1 | Input parameters | 43 |
| 11.2 | User Calibration | 44 |
| 11.3 | Auto Calibration | 44 |
| 11.4 | Output Option 1 parameters | 44 |
| 11.5 | Output Option 2 parameters | 45 |
| 11.6 | Output Option 3 parameters | 45 |
| 11.7 | Control | 46 |
| 11.8 | Setpoint | 47 |
| 11.9 | Alarm parameters | 47 |
| 11.10 | Display parameters | 48 |
| 11.11 | Communications | 48 |
| 11.12 | Manufacturing Information | 49 |
| 12 | Device Configurator PC Software | 50 |

| | | |
|-----------|---|-----------|
| 12.1 | Features | 50 |
| 12.2 | Brief Guide to Starting the Software | 51 |
| 13 | Thermocouple Identification and Ranges | 52 |
| 14 | Specifications | 53 |
| 15 | Glossary | 55 |
| 16 | Product Code | 71 |

1 Installation

1.1 Unpacking

Carefully remove the product from its packing. Please retain the packing for future use. The instrument is supplied with a panel gasket and push-fit fixing strap. A single sheet concise manual is also supplied in one or more languages. Examine the delivered items for damage or defects. If any are found, contact your supplier immediately.

1.2 Installation



Installation should be only performed by technically competent personnel. It is the responsibility of the installing engineer to ensure that the configuration is safe. Local Regulations regarding electrical installation & safety must be observed (e.g. US National Electrical Code (NEC) or Canadian Electrical Code).

1.3 Panel Cut-outs

The mounting panel must be rigid and may be up to 6.0mm (0.25 inches) thick.

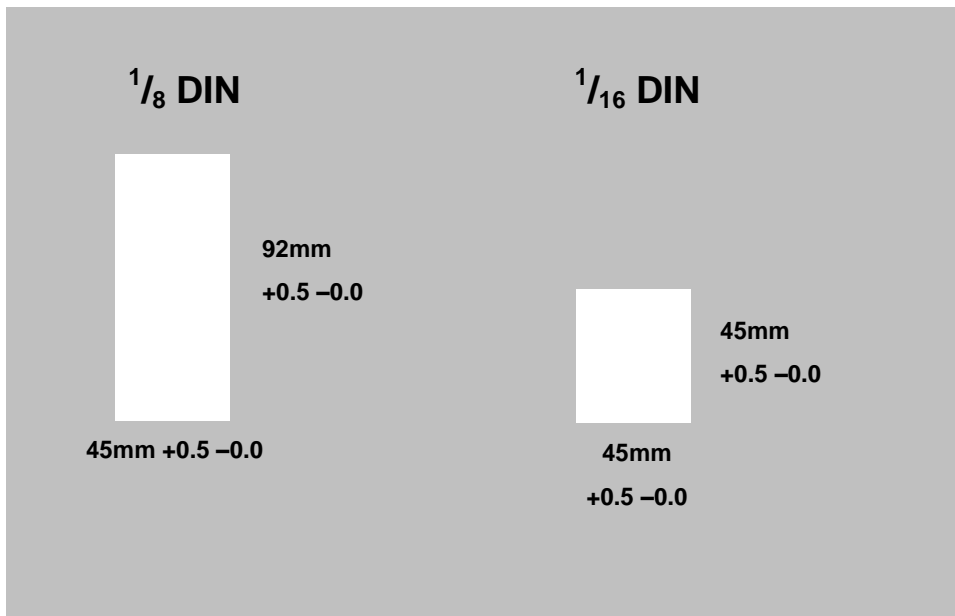

For n multiple instruments mounted side-by-side, cut-out width W is $48n-4$ mm.



Ensure there is adequate air flow inside the panel to prevent overheating.

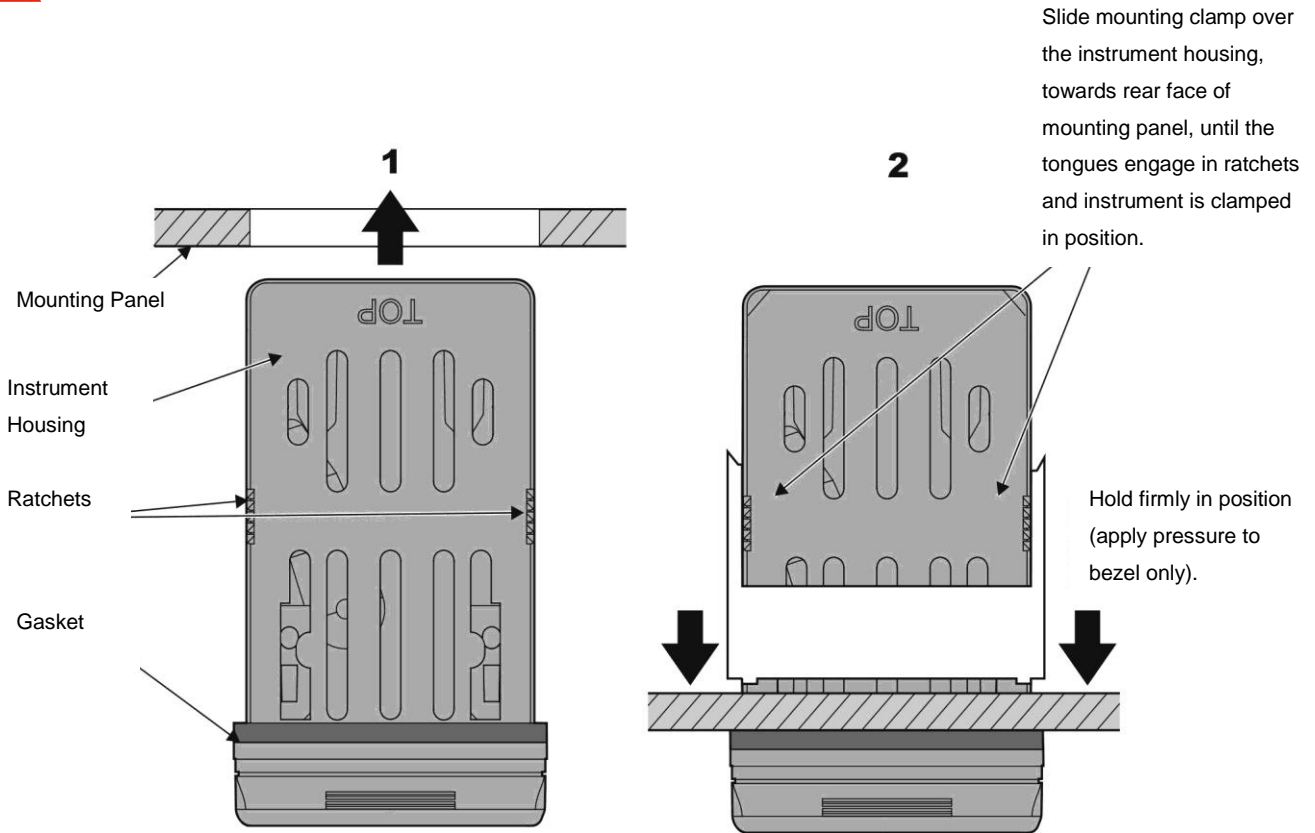

For an effective IP65 seal against dust and moisture, ensure gasket is firmly, but evenly, compressed against the panel, with the 4 tongues located in the same ratchet slot.

1.4 Cleaning

Clean the front panel by washing with warm soapy water and dry immediately.

2 Electrical Installation



The installation should be only performed by technically competent personnel.

It is the responsibility of the installing engineer to ensure that the configuration is safe.

Local Regulations regarding electrical installation & safety must be observed (e.g. US National Electrical Code (NEC) or Canadian Electrical Code).

2.1 Installation Considerations

Ignition transformers, arc welders, motor drives, mechanical contact relays and solenoids are examples of devices that generate electrical noise in typical industrial environments. The following guidelines **MUST** be followed to minimise their effects.

If the instrument is being installed in existing equipment, the wiring in the area should be checked to ensure that good wiring practices have been followed.

Noise-generating devices such as those listed should be mounted in a separate enclosure. If this is not possible, separate them from the instrument, by the largest distance possible. If possible, eliminate mechanical contact relays and replace with solid-state relays. If a mechanical relay cannot be replaced, a solid-state relay can be used to isolate the instrument.

A separate isolation transformer to feed only the instrumentation should be considered. The transformer can isolate the instrument from noise found on the AC power input.

2.2 AC Power Wiring - Neutral (for 100 to 240V AC versions)

It is good practice to ensure that the AC neutral is at or near ground (earth) potential. A proper neutral will help ensure maximum performance from the instrument.

2.3 Wire Isolation

Four voltage levels of input and output wiring may be used with the unit:

- Analogue input (for example thermocouple, RTD, VDC, mVDC or mADC)
- Relays & Triac outputs
- SSR Driver outputs
- AC power



The only wires that should run together are those of the same category.

If any wires need to run parallel with any other lines, maintain a minimum space of 150mm between them. If wires **MUST** cross each other, ensure they do so at 90 degrees to minimise interference.

2.4 Use of Shielded Cable

All analogue signals must use shielded cable. This will help eliminate electrical noise induction on the wires. Connection lead length must be kept as short as possible keeping the wires protected by the shielding. The shield should be grounded at one end only. The preferred grounding location is at the sensor, transmitter or transducer.

2.5 Noise Suppression at Source

Usually when good wiring practices are followed, no further noise protection is necessary. Sometimes in severe electrical environments, the amount of noise is so great that it has to be suppressed at source. Many manufacturers of relays, contactors, etc supply 'surge suppressors' which mount on the noise source. For those devices that do not have surge suppressors supplied, Resistance-Capacitance (RC) networks and/or Metal Oxide Varistors (MOV) may be added.

Inductive coils: - MOVs are recommended for transient suppression in inductive coils, connected in parallel and as close as possible to the coil. Additional protection may be provided by adding an RC network across the MOV.

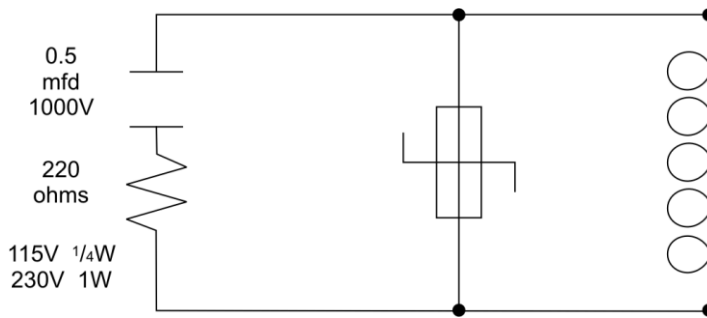

Contacts: - Arcing may occur across contacts when they open and close. This results in electrical noise as well as damage to the contacts. Connecting a properly sized RC network can eliminate this arc.

For circuits up to 3 amps, a combination of a 47 ohm resistor and 0.1 microfarad capacitor (1000 volts) is recommended. For circuits from 3 to 5 amps, connect two of these in parallel.

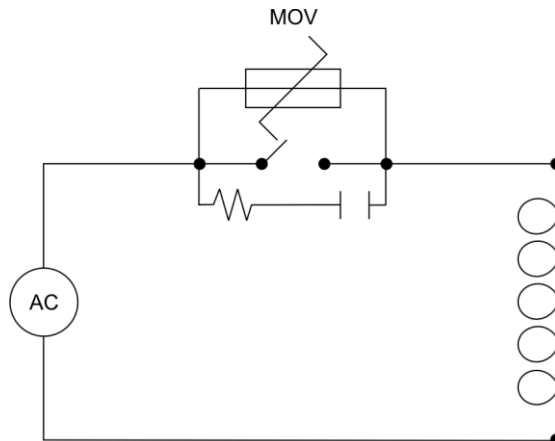

2.6 Sensor Placement (Thermocouple or RTD)

If the temperature probe is to be subjected to corrosive or abrasive conditions, it must be protected by an appropriate thermo-well. The probe must be positioned to reflect true process temperature:

In a liquid media - the most agitated area
In air - the best circulated area



The placement of probes into pipe work some distance from the heating vessel leads to transport delay, which results in poor control.

For a two wire RTD a wire link should be used in place of the third wire. Two wire RTDs must only be used with lead lengths less than 3 metres. Use of three wire RTDs is strongly recommended.

2.7 Rear Panel Wiring

The rear terminal connections for 1/16 DIN & 1/8 DIN instruments are compatible using A, B & C 1-6.

In general, all wiring connections are made to the instrument after it is installed.

Copper wires must be used for all connections (except thermocouple signal wires).



TO AVOID ELECTRICAL SHOCK, AC POWER WIRING MUST NOT BE CONNECTED TO THE SOURCE DISTRIBUTION PANEL UNTIL ALL WIRING PROCEDURES ARE COMPLETED.



CHECK THE INFORMATION LABEL ON THE CASE TO DETERMINE THE CORRECT VOLTAGE BEFORE CONNECTING TO A LIVE SUPPLY.

The diagram shows all possible option combinations. Please check the product configuration before wiring.

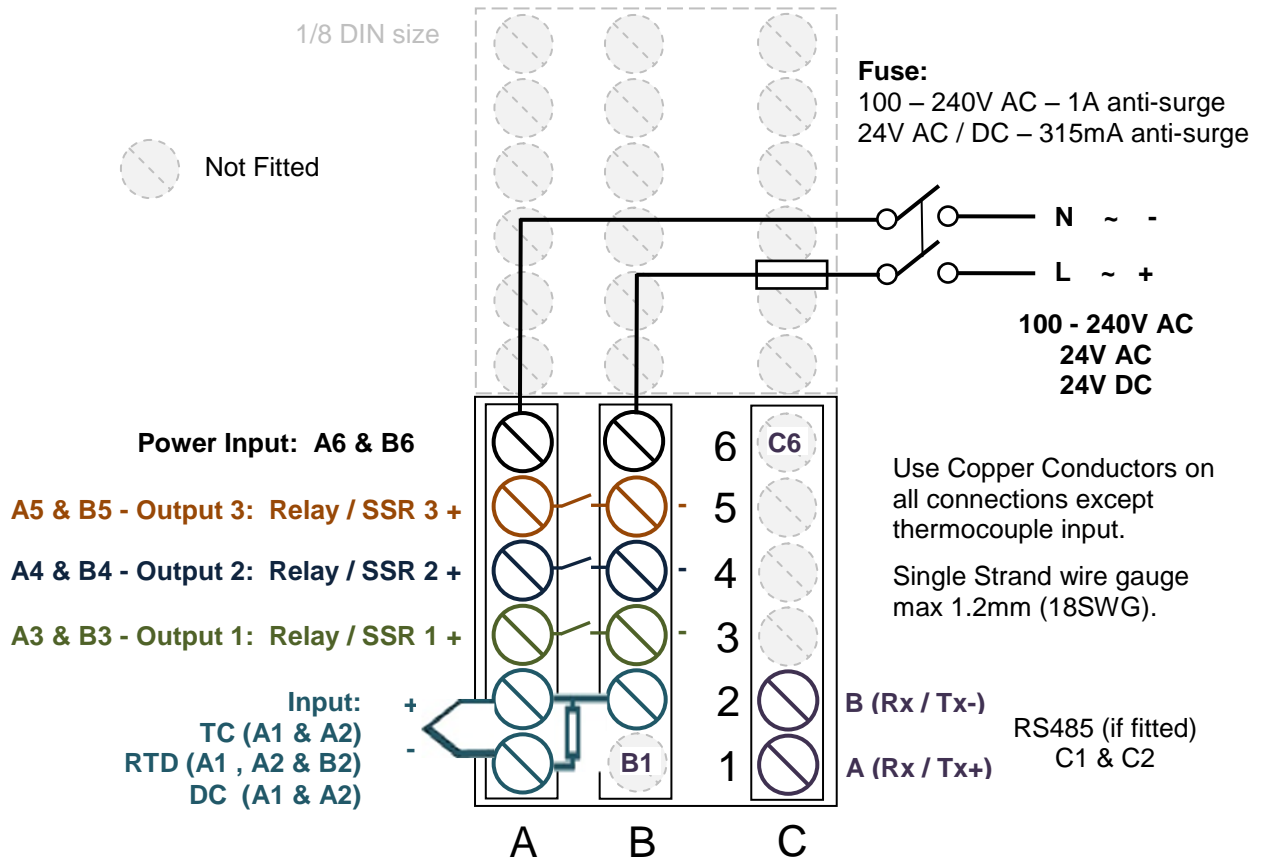

Dedicated Configuration Socket (on bottom of the instrument)

Warning: NEVER DIRECTLY CONNECT THIS SOCKET TO A USB PORT.



A configuration socket to USB adaptor can be obtained from your supplier.

3 Powering Up

ENSURE SAFE WIRING PRACTICES HAVE BEEN FOLLOWED. WHEN POWERING UP FOR THE FIRST TIME, DISCONNECT THE OUTPUT CONNECTIONS.



Check carefully the supply voltage and connections before applying power.

The instrument must be powered from a supply according to the wiring label on the side of the unit.

100 to 240V AC or

24 / 48V AC/DC depending upon the model purchased.

3.1 Powering Up Procedure

At power up, a self-test procedure is run, during which all LED segments are lit.

When powering up for the first time the instrument starts up in the Setup Mode and the parameter **TYPE** is displayed on the bottom LED display.



You must complete the Setup by cycling through all the parameters before using the device for the first time.

Please read next sections to understand navigation and use the Setup Mode (First Power-Up) to configure the device.

On subsequent start-up the instrument will enter the User Mode after self-test.

Any future access to the Setup or Advanced Configuration Modes is lock code protected.

3.2 Auto-Tune

The controller can be auto-tuned from the Setup Mode.

PrE Pre-tune

AtSP Auto-tune at setpoint



Auto-tuning will not engage if:

- Controller is set to On/Off control (**H_Pb = On.Off**)
- Setpoint is ramping
- PV is within 5% of the input range from Setpoint.

3.3 Front Panel

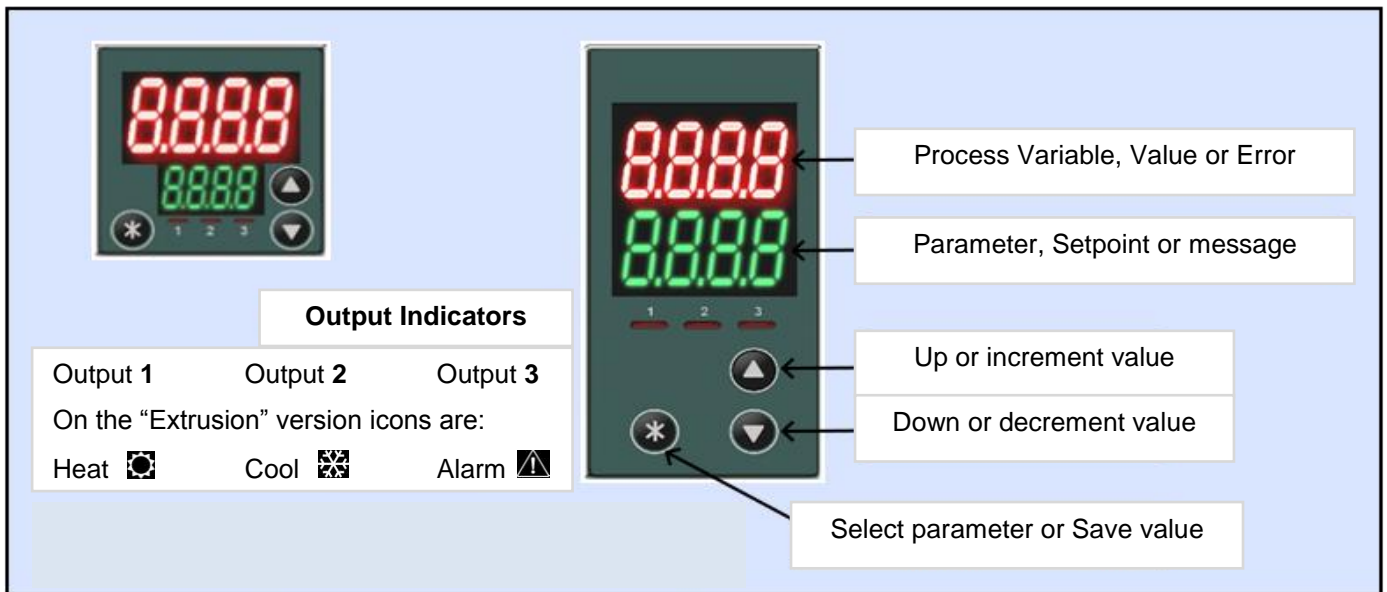

3.4 General Navigation

- Press ▲ or ▼ to navigate between parameters or modes
- To select and edit a parameter, or to enter a mode, press *
- The parameter name in the lower display now flashes ready for editing
- Press ▲ or ▼ to change the parameter value in the upper display
- Press * within 60 seconds to save the change, otherwise the change is rejected

The LED displays describe the parameters and values you are editing.

3.5 Device Configuration

The device can be configured from the front panel or via the configuration software. Connection can be either via the dedicated configuration socket or via RS-485.



Warning: Never connect the instrument's configuration socket directly to a USB port as it will damage the controller.

3.6 Mode (or Menu) Structure

There are 3 main modes (or menus) on the device – User, Setup and Advanced Configuration Mode.

- **User Mode** - the live screen used for normal operation. The process variable can always be seen in this mode
- **Setup Mode** – allows access to the most important parameters
- **Advanced Configuration Mode** - access all parameters via sub-menus



Hold * and press ▲ for Set-up menu.

Hold * and press ▼ for Advanced Configuration Mode.



The device detects what options are purchased and intelligently hides parameters that are not relevant to your current configuration.

Some parameters on the “Plastics Extrusion” Controller version differ from the standard controller. Please see section “Extrusion” Version Controller sub-menus later.

3.7 Returning to User Mode

Hold * and press ▲.

From a sub-menu you will need to do this twice - once to return to Advanced Configuration Mode (*Adu*) then again to exit *Adu*.

You will return to the normal User Mode with the PV displayed.

3.8 Mode Access and Lock Codes

Separate lock codes can be set for the Setup Mode (First Power-Up) and for the Advanced Configuration Mode (*Adu*).

S.Loc Setup Mode lock code – default *10*.

A.Loc Advanced Configuration Mode lock code – default *20*.



Hold ▼ button whilst powering up for a read-only view of lock codes.

3.9 Use of the Controller for Non-Temperature Applications

In the majority of applications this controller will be used for temperature sensing, either via a sensor or a linear dc input, which use heat and cool. However this controller can be used for other types of processes.

If your process is not a temperature then the parameters labelled as “HEAT” refer to reverse acting outputs used to increase the process value and “COOL” to decrease the process value.

As an example you may have a system that reads and controls humidity. The “HEAT” output drives the humidifier and the “COOL” output drives the de-humidifier. Use the “HEAT” parameters to control the humidifier and the “COOL” parameters to control the de-humidifier.

Often the “HEAT” and “COOL” is referred to as “Primary” and “Secondary” on other controllers.

3.10 Warnings and Error Messages

| | Lower | Upper | Meaning & Visibility |
|-------------------------|--|-------|--|
| Alarm Active | | -AL- | One or more alarms are active. Alternates with the PV. (Display is optional – see <i>USER</i>) |
| Outputs Latched | | Ltch | One or more outputs are latched on <u>and</u> no alarm is active. Alternates with the PV. |
| Input Over Range | | -HH- | Process variable input >5% over-range, i.e. above maximum |
| Input Under Range | | -LL- | Process variable input >5% under-range, i.e. below minimum |
| Input Sensor Break | OFF | OPEN | Break detected in process variable input sensor or wiring |
| Un-calibrated Input | OFF | Err | Selected input range has not been calibrated |
| Manual Power | Pxxx | | Manual percentage power (-100% to 100%) |
| Setpoint Ramping | SPr | | Setpoint ramp is active (alternates with setpoint) |
| Control Disabled | OFF | | Control outputs are off. (<i>Ctrl=OFF</i>). To resolve set (<i>Ctrl=On</i>) |
| Control Delayed | dLY | | Visible if control delayed by Delayed Start Time (<i>d.t</i>) |
| Automatic Tuning | tunE | | Tuning is active |
| Automatic Tuning Errors | The tune error code appears if tune attempt fails. Set tune to OFF to clear | | |
| | tEr1 | | PV is within 5% of setpoint |
| | tEr2 | | Setpoint is ramping |
| | tEr3 | | Control is ON/OFF (<i>H.Pb</i> or <i>C.Pb = 0</i>) |
| | tEr4 | | Control is Manual |
| | tEr5 | | Pulse tune not able to run |
| | tEr6 | | Sensor break |
| | tEr7 | | Timer running |
| | tEr8 | | Control is disabled (<i>Ctrl=OFF</i>) |

4 Setup Mode (First Power-Up)

The device will enter the Setup menu on the first power-up. This menu gives easy access to some of the most commonly required settings.

The entry is lock code protected; see Mode Access and Lock Codes.

| | | | |
|-----------|--------|----|--|
| Lock Code | 5 .Loc | 10 | Lock code to enter Setup Mode. Default is 10. |
|-----------|--------|----|--|

| Parameter Name | Lower | Upper | Meaning & Visibility |
|----------------------------|---------------|---------------------------------|---|
| Input Type | TYPE | TC_J | J thermocouple - Default is TC_J |
| | | TC_K | K thermocouple |
| | | P_100 | PT100 |
| | | TC_B | B thermocouple |
| | | TC_C | C thermocouple |
| | | TC_L | L thermocouple |
| | | TC_N | N thermocouple |
| | | TC_R | R thermocouple |
| | | TC_S | S thermocouple |
| | | TC_T | T thermocouple |
| | | 0_20 | 0 - 20 mA dc ** |
| | | 4_20 | 4 - 20mA dc ** |
| | | 0_50 | 0 - 50mV dc |
| | | 10_50 | 10 - 50mV dc ** |
| | | 0_5 | 0 - 5V dc ** |
| | | 1_5 | 1 - 5V dc ** |
| | | 0_10 | 0 - 10V dc ** |
| 2_10 | 2 - 10V dc ** | | |
| Input Units | | C | Select °C or °F temperature units – Default is C |
| | | F | |
| Process Display Resolution | dEc .P | 0000 000.0 00.00 0.000 | Number of decimal places. (2 or 3 decimal places not available for temperature input). Default is 0000 |

** Not available on “Extrusion” version.

| Parameter Name | Lower | Upper | Meaning & Visibility |
|-----------------------------|-------|--|--|
| Scale Range Upper Limit | ScUL | | Upper limit of scaled input range. (Only visible in Setup Mode when a dc linear type is selected). Default is input max |
| Scale Range Lower Limit | ScLL | | Lower limit of scaled input range. (Only visible in Setup Mode when a dc linear type is selected). Default is input min |
| Output 1 Usage | Out1 | HEAT COOL AL1 AL2 AL12 Loop | Heat, Cool, Alarm 1, Alarm 2, both Alarms, or Loop Alarm. Default is HEAT |
| Output 2 Usage | Out2 | | Same options as Output 1. Out2 Default is AL1 |
| Output 3 Usage | Out3 | | Out3 Default is AL2 |
| Alarm 1 Adjust | AL_1 | | Sets the Alarm 1 value. (Range minimum to range maximum) OFF disables the alarm. (Default alarm type is high alarm) |
| Alarm 2 Adjust | AL_2 | | Sets the Alarm 2 value. (Range minimum to range maximum) OFF disables the alarm. (Default alarm type is low alarm) |
| Setpoint Adjust | SP | | Target setpoint. Adjustable between setpoint upper and lower limits Default is 0 |
| Automatic Tuning Start/Stop | tunE | OFF PrE ALSP | OFF use current PID control terms or manually tune. PrE start pre-tune ALSP tune at setpoint Default is OFF |



Important Note 1: You will be returned to the Setup mode on every subsequent power up unless you scroll through all of the Setup parameters, and then exit from the Setup mode to save the values.



Important Note 2: The parameter **Ctrl** (discussed later in the manual) is set to **On** and the Setpoint to **0** by default when the first Setup is complete. This means the controller outputs are on with a setpoint of 0.

5 User Mode

The normal, live screen showing the PV (process variable) or temperature is called the User Mode.

The behaviour of this screen is controlled by a parameter called Basic Setpoint Control (*bASc*) found in the Display *d,SP* sub-menu, and visibility settings within the Operator sub-menu, *OPtr*.

5.1 Basic Setpoint Control - Disabled

The first screen shows either the setpoint or manual power.

| | | | |
|----------------|--|----------------|--|
| PV from sensor | | PV from sensor | |
| Setpoint | | Manual power | |

| <i>bASc</i> = <i>d,SA</i> Basic Mode Disabled | | | *(parameters not available on "Extrusion" version) | when <i>OPtr</i> is |
|---|-------|-----------|--|---------------------|
| <i>PTCt</i> = OFF (Auto) | 190 | 51 | Target setpoint adjustable | SHLW |
| <i>PTCt</i> = ON (Man) | P 90 | 51 | Manual power adjustable | SHLW |
| Alarm Status | ALSt | | Active when alarms are active – L2 I I = Alarm 1 active 2 = Alarm 2 active L = Loop Alarm active | SHLW |
| Latch Status | LAth | | Active when an output is latched – 123 I = Output 1 2 = Output 2 3 = Output 3 | SHLW |
| Maximum PV | P7A | | (Read-only) Displays maximum PV since power up or last reset. (To clear press *). | SHLW |
| Minimum PV | P7n | | (Read-only) Displays maximum PV since power up or last reset. (To clear press *). | SHLW |
| Control Enabled | CntL | OFF On | Control output(s) disabled Control output(s) enabled – PID or On/Off control available | SHLW |
| Manual Control Enabled | PTCt | OFF On | Automatic control mode Manual control mode (P xxx shown on the SP screen) | SHLW |
| Time On Remaining | Ont I | | Active when On timer is on ** | SHLW |
| Delay Time Remaining | dLt I | | Active when Delay timer is on ** | SHLW |

5.2 Basic Setpoint Control - Enabled

If Basic Setpoint Control is enabled either the setpoint or manual power will be adjustable only.

In basic mode PV is always shown on the upper display, with auto or manual power below.

| | | | |
|----------------|--|----------------|--|
| PV from sensor | | PV from sensor | |
| Setpoint | | Manual power | |

| | Active Parameter | |
|-----------------------------------|----------------------------|------|
| $\text{PACT} = \text{OFF}$ (Auto) | Target setpoint adjustable | 180 |
| $\text{PACT} = \text{ON}$ (Man) | Manual power adjustable | P 95 |

Any parameters hidden when Basic Setpoint Control is enabled are accessible via the Advanced Configuration sub-menus.

5.3 Comparing Basic Setpoint Control Enabled with Disabled

| $\text{bASc} = \text{EnAb}$ Basic Setpoint Control <u>Enabled</u> | | |
|--|---|---|
| Parameter | User Mode screen | sub-menu |
| ALSt | Not Visible | Visible (when alarms are on) in USER |
| LAth | | Visible in USER |
| PnA | | Visible in USER |
| Pn in | | Visible in USER |
| CntL | | Visible in USER |
| PACT | | Visible in USER |
| OnE , | | Visible in SPt , (Standard version only) |
| dLE , | | Visible in SPt , (Standard version only) |
| $\text{bASc} = \text{dISA}$ Basic Setpoint Control <u>Disabled</u> | | |
| Parameter | User Mode screen | sub-menu OPtr (Show or Hide) |
| ALSt | Depends on OPtr setting (when alarms are on) | SHLJ or H idE |
| LAth | Depends on OPtr setting (when alarms are on) | SHLJ or H idE |
| PnA | Depends on OPtr setting | SHLJ or H idE |
| Pn in | Depends on OPtr setting | SHLJ or H idE |
| CntL | Depends on OPtr setting | SHLJ or H idE |
| PACT | Depends on OPtr setting | SHLJ or H idE |
| OnE , | Depends on OPtr setting (when alarms are on) | SHLJ or H idE |
| dLE , | Depends on OPtr setting (when delay timer is on) | SHLJ or H idE |

6 Advanced Configuration Mode (Adu)

The Advanced Configuration Mode allows access to all the parameters, including those accessible in the Setup Mode.



It may be faster to access some parameters from the Setup Mode.

There is a factory default option available in the Display sub-menu.

Entry is lock code protected; see Mode Access and Lock Codes.

Whilst in the Advanced Configuration Mode **Adu** is visible on the lower display.

| | | | |
|-----------|---------------|-----------|--|
| Lock Code | A .Loc | 20 | Lock code to enter Advanced Configuration mode. Default = 20. |
|-----------|---------------|-----------|--|

The Advanced Configuration Mode contains the sub-menus shown below. Once inside a sub-menu the parameter name and value are displayed.

| | |
|-----------|-------------|
| Value | tC-J |
| Parameter | tYPE |

| Sub-Menu Name | Lower | Upper | Meaning & Visibility |
|---------------|-------------|--|---|
| User | Adu | USER | Provides access to User parameters including Control Enabled and Manual Control Enabled parameters. |
| Input | | InPt | Set up input sensor and range. |
| Calibration | | CAL | For entering up to 2 input calibration points. |
| Output | | OUTP | Set functions for up to 3 outputs. |
| Control | | COnt | Control settings for PID, or ON/OFF control, and Auto-tune. |
| Setpoint | | SPt , | Setpoint and timer settings. |
| Alarm | | ALrT | All alarm settings including sensor break alarm. |
| Comms | | CoM | Modbus address, baud rate and parity - only shown if RS485 option is fitted. |
| Display | | dISP | Lock code set up and Basic Setpoint Control enable/disable. |
| Operator | | OPtr | Visibility setting for parameters that can be made visible in the User Mode. |
| Info | InFo | Revision level, Firmware version, Serial number and Manufactured date. | |

6.1 User sub-menu (USER)

| Parameter | Lower | Upper | Meaning & Visibility | Default |
|-----------------------|-------|-----------|---|---------|
| Alarm Status | ALSt | | Visible when alarms are active – L21 1 = Alarm 1 active 2 = Alarm 2 active L = Loop Alarm active | |
| Latch Status | LAth | | Active when an output is latched – 123 1 = Output 1 2 = Output 2 3 = Output 3 | |
| Maximum PV | P7A | | Maximum and Minimum PV recorded whilst powered up or since last reset. To clear press * then to select YES . Press * to accept. | |
| Minimum PV | P7in | | | |
| Control Enable | CnEL | OFF On | OFF = Control output(s) disabled On = Control output(s) enabled – PID or On/Off control available | On |
| Manual Control Enable | P7Ct | OFF On | Auto or Manual power control. OFF = auto | OFF |

6.2 Input sub-menu (InPt)

| | Lower | Upper | Meaning & Visibility | Default |
|-------|-------|-------|---|---------|
| Input | TYPE | tc_J | J thermocouple -200 to 1200°C (-328 to 2192°F) -128.8 to 537.7°C (-199.9 to 999.9°F) | tc_P |
| | | tc_K | K thermocouple -240 to 1373°C (-400 to 2503°F) -128.8 to 537.7°C (-199.9 to 999.9°F) | |
| | | P100 | PT100 -199 to 800°C (-328 to 1472°F) -128.8 to 537.7°C (-199.9 to 999.9°F) | |
| | | tc_B | B thermocouple 100 to 1824°C (211 to 3315°F) | |
| | | tc_C | C thermocouple 0 to 2320°C (32 to 4208°F) | |
| | | tc_L | L thermocouple 0 to 762°C (32 to 1403°F) 0.0 to 537.7°C (32.0 to 999.9°F) | |
| | | tc_N | N thermocouple 0 to 1399°C (32 to 2551°F) | |
| | | tc_R | R thermocouple 0 to 1795°C (32 to 3198°F) | |
| | | tc_S | S thermocouple 0 to 1762°C (32 to 3204°F) | |
| | | tc_t | T thermocouple -240 to 400°C (-400 to 752°F) -128.8 to 400°C (-199.9 to 752.0°F) | |

| | Lower | Upper | Meaning & Visibility | Default |
|----------------------------|--------|---------------------------------|--|----------------------|
| | | 0_20 | 0 - 20 mA dc ** | |
| | | 4_20 | 4 – 20 mA dc ** | |
| | | 0_50 | 0 – 50 mV dc | |
| | | 10_50 | 10 – 50 mV dc ** | |
| | | 0_5 | 0 – 5 V dc ** | |
| | | 1_5 | 1 – 5 V dc ** | |
| | | 0_10 | 0 – 10 V dc ** | |
| | | 2_10 | 2 – 10 V dc ** | |
| Input Units | | C F | Select either °C or °F temperature units. | C |
| Process Display Resolution | dEc .P | 0000 000.0 00.00 0.000 | Number of decimal places. (2 or 3 decimal places not available for temperature input types). | 0000 |
| Scale Range Upper Limit | ScUL | | Upper limit of scaled input range. Scale input lower limit +100 display units to range maximum | Input Max (Lin=1000) |
| Scale Range Lower Limit | ScLL | | Lower limit of scaled input range. Range minimum to scale input upper limit -100 display units | Input Min (Lin=0) |
| Input Filter Time | F .Lt | | OFF or 0.5 to 100.0 seconds in 0.5 increments | 2.0 |
| Cold Junction Compensation | CJC | On OFF | Enables the internal thermocouple CJC. When OFF External compensation must be provided for thermocouples. | On |

** Not available on “Extruder” version.

6.3 Calibration sub-menu (CAL)

| | Lower | Meaning & Visibility | Default |
|------------------------|-------|--|-------------|
| Single Point Offset | OFFS | Shifts the input value up or down across the entire range, by the value entered. | 0 |
| Low Calibration Point | L.CAL | The value at which the low point error was measured is to be applied. | Lower limit |
| Low Offset | L.OFF | Enter an equal, but opposite offset value to the observed low point error. | 0 |
| High Calibration Point | H.CAL | The value at which the high point error was measured. | Upper limit |
| High Offset | H.OFF | Enter an equal, but opposite offset value to the observed high point error. | 0 |

Please refer to section Calibration Mode.

6.4 Output sub-menu (OUTP)

| | Lower | Upper | Meaning & Visibility | Default |
|---------------------------|-------|---|---|---------|
| Output 1 Usage | OUT 1 | HEAT COOL AL 1 AL 2 AL 12 Loop | Choose the function for Output 1 from: Heat, Cool, Alarm 1, Alarm 2, Alarm 1 or 2, or Control Loop Alarm (2x integral time) | HEAT |
| Output 1 Alarm Action | Act 1 | d ir rEu | Output changes with alarm (d ir) Output changes in opposition to alarm (rEu) | d ir |
| Output 1 Alarm Latching | LAc 1 | OFF On | Latching OFF or On. (Once on output must be reset to turn off.) | OFF |
| LED Indicator 1 Inverting | Ind 1 | d ir rEu | Output 1 LED indicator changes with alarm (d ir) Output 1 LED indication changes in opposition to alarm (rEu) | d ir |
| Output 2 Usage | OUT2 | | Same options as Output 1 Usage | AL 1 |
| Output 2 Alarm Action | Act2 | | Same options as Output 1 Alarm Action | d ir |
| Output 2 Alarm Latching | LAc2 | | Same options as Output 1 Alarm Latching | OFF |
| LED Indicator 2 Inverting | Ind2 | | Same options as LED Indicator 1 Inverting | d ir |
| Output 3 Usage | OUT3 | | Same options as Output 1 Usage | AL 2 |
| Output 3 Alarm Action | Act3 | | Same options as Output 1 Alarm Action | d ir |
| Output 3 Alarm Latching | LAc3 | | Same options as Output 1 Alarm Latching | OFF |
| LED Indicator 3 Inverting | Ind3 | | Same options as LED Indicator 1 Inverting | d ir |

6.5 Control sub-menu (Control)

| | Lower | Meaning & Visibility | Default |
|----------------------------|-------|---|---------|
| Heat Proportional Band | H_Pb | (Primary if not temperature) | 16.1 |
| Cool Proportional Band | C_Pb | (Secondary if not temperature) | 16.1 |
| Automatic Reset | Int | Integral time for PI or PID control. I seconds to 99 minutes 59 seconds and OFF | 5.00 |
| Rate (Derivative time) | dEr.t | D term for PD or PID. OFF 0 seconds to 99 minutes 59 seconds | 1.15 |
| Overlap / Deadband | O_d | In display units, range -20 to +20% of Heat and Cool Proportional Band | 0 |
| ON/OFF differential | dIFF | On/Off switching point. In display units, centred about the setpoint, range: 0.1% to 10.0% of input span | 8 |
| Loop Alarm Time | LA.t | Visible when using On/Off control (i.e. when H_Pb or C_Pb = On,OFF) Sets the time to wait before the loop alarm becomes active. Default 99 mins 99 secs. (If PID then the Loop Alarm Time is 2x integral time) | 99.99 |
| Manual Reset (Bias) | bIAS | Biasing of Proportional Control output. 0 to 100% (heat only) - 100% to 100% (if heat/cool control) | 25 |
| Heat Cycle Time | HcYc | Time proportion cycle time for the outputs | 32.0 |
| Cool Cycle Time | CcYc | 0.1 to 512.0 seconds | 32.0 |
| Heat & Cool Output Inhibit | OPLC | Inhibits the simultaneous activation of both heat and cool outputs. | OFF |

| | Lower | Meaning & Visibility | | Default |
|-----------------------------|-------------|---|---|-------------|
| Heat Power Limit | <i>HPL</i> | Heating/Primary % power upper limit <i>0</i> to <i>100</i> % | | <i>100</i> |
| Cool Power Limit | <i>CPL</i> | Cooling/Secondary % power upper limit <i>0</i> to <i>100</i> % | | <i>100</i> |
| Power Up Action | <i>PUP</i> | <i>LAST</i> <i>On</i> | <i>LAST</i> = Powers up with control enable in the same state as on power fail <i>On</i> = Always powers up with control enabled | <i>LAST</i> |
| Automatic Tuning Start/Stop | <i>tunE</i> | <i>OFF</i> <i>PrE</i> <i>AtSP</i> | <i>OFF</i> = use current PID control terms or manually tune. <i>PrE</i> = start pre-tune <i>AtSP</i> = tune at setpoint | <i>OFF</i> |

6.6 Setpoint sub-menu (SPt)

| | Lower | Upper / Meaning & Visibility | | Default |
|----------------------|-------------|------------------------------|---|-------------|
| Timer Enable | <i>tEnb</i> | <i>EnAb</i> <i>d,SA</i> | <i>EnAb</i> = Enables the delay and on timers, functions only at the next power-up / control enable. <i>d,SA</i> = Delay and on timers, are ignored, but <u>setpoint ramping is not disabled</u> . | <i>d,SA</i> |
| Delayed Start Time | <i>d_t,</i> | | The time from power-up or a control enable request before control begins, from 00.01 to 99.59 (Hours.Minutes) or OFF . Control disabled until time elapsed. | OFF |
| Setpoint Ramp Rate | <i>rAtE</i> | | The rate (in units / hour) <u>from current PV</u> to setpoint following power-up or control enable. From 0.001 to 9999 (Hours.Minutes) or OFF . Setpoint value changes also follow this rate. | OFF |
| On Time | <i>0_t,</i> | | The time the target setpoint will be maintained once reached, from 00.01 to 99.59 (Minutes .Seconds) or INF . Control remains on indefinitely if set to INF . | INF |
| Setpoint Upper Limit | <i>SPuL</i> | | The maximum allowed setpoint value, from current setpoint to scaled upper limit. | Upper Limit |
| Setpoint Lower Limit | <i>SPlL</i> | | The minimum allowed setpoint value, from current setpoint to scaled lower limit. | Lower Limit |

Standard Controller Setpoint

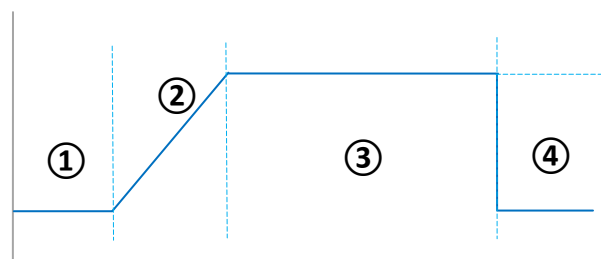

- ① At switch on or from control enable the unit will delay enabling control until the start timer (Delayed Start Time - *d_t*) expires.
- ② The setpoint then ramps from the current PV to the setpoint at the Setpoint Ramp Rate.
- ③ When a ramp rate is not defined the active setpoint will step directly to the target setpoint. Once the active setpoint reaches the target setpoint, the 'on' timer (On Time - *0_t*) starts.
- ④ When the on timer expires the control switches off.

If no time is defined for the on timer (*0_t*), control continues indefinitely unless manually disabled.

6.7 Alarm sub-menu (AL??)

| | Lower | Upper | Meaning & Visibility | Default |
|--------------------|-------|-------------------------------------|---|---------|
| Alarm 1 Type | AL1t | nonE P_h, P_Lo dEv bAnd | Set the function of Alarm 1: None, process High, process Low, Deviation or Band | P_H, |
| Alarm 1 Value | AL_1 | | Set the trigger point / value of Alarm 1 Range minimum to range maximum OFF disables the alarm. | 1373 |
| Alarm 1 Hysteresis | HYS1 | | The Alarm 1 switching point hysteresis 0 to full span. | 1 |
| Alarm 2 Type | AL2t | | Same options as Alarm 1 settings | P_Lo |
| Alarm 2 Value | AL_2 | | | -240 |
| Alarm 2 Hysteresis | HYS2 | | | 1 |
| Alarm Inhibit | inh, | nonE 1 2 1 2 | Inhibit alarms if active at power-up and on change in setpoint. None, Alarm 1, Alarm 2, Alarm 1 & 2. | nonE |
| Alarm Notification | NotE | nonE 1 2 1 2 | Enable alarm notification in the User Mode. Alternating indication -AL- shown when alarms are active. None, Alarm 1, Alarm 2, Alarm 1 & 2. | 2 |
| Sensor Break Alarm | SbAc | On OFF | On = activates both alarms when a sensor break is detected. | OFF |

6.8 Comms sub-menu (Co??)

| | Lower | Upper | Meaning & Visibility | Default |
|----------------|-------|-------|--|---------|
| Modbus Address | Add | | The device network address from 1 to 255 | 1 |
| Baud Rate | bAud | | The communications data rate in kbps from 1.2 (1200), 2.4 (2400), 4.8 (4800), 9.6 (9600), 9.2 (19200), 38.4 (38400). | 9.6 |
| Parity | PrtY | | Parity checking: Odd , Even or nonE | nonE |

6.9 Display sub-menu (d,SP)

| | Lower | Meaning & Visibility | Default |
|---------------------------------------|-------|---|-------------|
| Setup Lock Code | S.Loc | Set lock code for the Setup mode. OFF , 1 to 9999 . | 10 |
| Advanced Configuration Lock Code | A.Loc | Set lock code for the Advanced Configuration mode. OFF , 1 to 9999 . | 20 |
| Basic Setpoint Control Enable/Disable | bASc | Basic Setpoint Control allows user to only change the setpoint or manual power. | d,SA |
| Reset to Defaults | dFLt | Reset all parameters back to their factory defaults. Press * and select YES | |

6.10 Operator sub-menu (OPt,r)

| | Lower | Upper | Meaning & Visibility | Default |
|------------------------|-------|---------------|---|---------|
| PV Maximum | PMA | H idE SHLd | Hide or show parameter in User Mode. | H idE |
| PV Minimum | PMin | | Please refer to the User sub-menu (USER). | H idE |
| Alarm Status | ALSt | | Hide or show in User Mode. | H idE |
| Latch Status | LAth | | Hide or show in User Mode. | SHLd |
| Control Enabled | CntL | | Hide or show in User Mode. Please refer to the User sub-menu (USER). | H idE |
| Manual Control Enabled | PnCt | | Hide or show in User Mode. Please refer to the Setpoint sub-menu (SPt,). | H idE |
| Time On Remaining | Ont I | | | H idE |
| Delay Time Remaining | dLt I | | | H idE |

6.11 Info sub-menu (Info)

This is a read only view so parameters cannot be altered.

| | Lower | Meaning & Visibility |
|---------------------|-------|---|
| Product Revision | PrL | The hardware and software revision level. |
| Firmware Type | FtYP | The firmware code type. |
| Firmware Issue | ISS | The firmware version number |
| Serial Number 1 | SEr 1 | First four digits of serial number |
| Serial Number 2 | SEr 2 | Middle four digits of serial number |
| Serial Number 3 | SEr 3 | Last four digits of serial number |
| Date of Manufacture | dOPg | Manufacturing date code (mmyy) |

7 “Extrusion” Version Controller sub-menus

The “Extrusion” version controller has different Output, Control, Setpoint and Alarm sub-menus, compared to the standard model. Sub-menus not listed below are identical to the standard version.

7.1 Output sub-menu (OUTP) “Extrusion” version

| | Lower | Upper | | Default |
|-------------------------|-------|--|--|---------|
| Output 1 Usage | OUT1 | HEAT COOL nLCL AL1 AL2 AL12 Loop | Non-Linear Cooling is added in the “Extrusion” version | HEAT |
| Output 1 Alarm Action | Act1 | dir rEu | Output changes with alarm (dir) Output changes in opposition to alarm (rEu) | dir |
| Output 1 Alarm Latching | LAc1 | OFF On | Latching OFF or On. (Once on output must be reset to turn off.) | OFF |
| Output 2 Usage | OUT2 | | Same options as Output 1 Usage | AL1 |
| Output 2 Alarm Action | Act2 | | Same options as Output 1 Alarm Action | dir |
| Output 2 Alarm Latching | LAc2 | | Same options as Output 1 Alarm Latching | OFF |
| Output 3 Usage | OUT3 | | Same options as Output 1 Usage | AL2 |
| Output 3 Alarm Latching | LAc3 | | Same options as Output 1 Alarm Latching | OFF |

7.2 Control sub-menu (CONT) “Extrusion” version

| | Lower | Meaning & Visibility | Default |
|------------------------|-------|---|---------|
| Heat Proportional Band | H_Pb | (Primary if not temperature) In display units. 0.0 (oNof) and range: 0.5% to 999.9% of input span. | 16.1 |
| Cool Proportional Band | C_Pb | (Secondary if not temperature) | 16.1 |
| Automatic Reset | Int | Integral time for PI or PID control. I seconds to 99 minutes 59 seconds and OFF | 5.00 |
| Rate (Derivative time) | dEr.t | D term for PD or PID. OFF 0 seconds to 99 minutes 59 seconds | 1.15 |
| Overlap / Deadband | O_d | In display units, range -20 to +20% of Heat and Cool Proportional Band | 0 |
| ON/OFF differential | d ,FF | On/Off switching point. In display units, centred about the setpoint, range: 0.1% to 10.0% of input span | 8 |

| | Lower | Meaning & Visibility | Default |
|-----------------------------|---|---|--------------|
| Loop Alarm Time | LAt | Visible when using On/Off control (i.e. when H_Pb or C_Pb = On,OF) Sets the time to wait before the loop alarm becomes active. Default 99 mins 99 secs. (If PID then the Loop Alarm Time is 2x integral time) | 99.99 |
| Manual Reset (Bias) | bAS | Biasing of Proportional Control output. 0 to 100% (heat only) - 100% to 100% (if heat/cool control) | 25 |
| Soft Start Time | SSt | 0 (OFF) to 60 hours | OFF |
| Soft Start Setpoint | SSP | Soft start target setpoint adjustable between scale input upper and lower limits | -240 |
| Heat Cycle Time | HcYc | Time proportion cycle time for the outputs 0.5 to 512.0 seconds | 32.0 |
| Cool Cycle Time | CcYc | | 32.0 |
| Heat & Cool Output Inhibit | OPLC | Inhibits the simultaneous activation of both heat and cool outputs. | OFF |
| Heat Power Limit | HPL | Heating/Primary % power upper limit 0 to 100% | 100 |
| Cool Power Limit | CPL | Cooling/Secondary % power upper limit 0 to 100% | 100 |
| Cooling Minimum | COOL | Range minimum to range maximum | 120 |
| Impulse Length | t.on | 1 to 9999 seconds | 10 |
| Minimum Off Time | t.off | Soft start target setpoint adjustable between scale input upper and lower limits | 20 |
| Non-linear Cooling Adjust | C.AdJ | 0 to 9999 (no units) | 5 |
| Power Up Action | PUP LAST On | LAST = Powers up with control enable in the same state as on power fail On = Always powers up with control enabled | LAST |
| Automatic Tuning Start/Stop | tunE OFF PrE AtSP | OFF = use current PID control terms or manually tune. PrE = start pre-tune AtSP = tune at setpoint | OFF |

7.3 Setpoint Sub-menu (SP) “Extrusion” version

| | Lower | Upper / Meaning & Visibility | Default |
|----------------------|-------|---|-------------|
| Setpoint Ramp Rate | rAtE | The rate (in units / hour) from current PV to setpoint following power-up or control enable. From 0.00 l to 9999 (Hours.Minutes) or OFF. Setpoint value changes also follow this rate. | OFF |
| Setpoint Upper Limit | SPuL | The maximum allowed setpoint value, from current setpoint to scaled upper limit. | Upper Limit |
| Setpoint Lower Limit | SPLl | The minimum allowed setpoint value, from current setpoint to scaled lower limit. | Lower Limit |

7.4 Alarm sub-menu (ALr 7) “Extrusion” version

| | Lower | Upper | Meaning & Visibility | Default |
|-------------------------------|--------|-------------------------------------|--|---------|
| Alarm 1 Type | AL1t | nonE P_h, P_Lo dEv bRnd | Set the function of Alarm 1: None, process High, process Low, Deviation or Band | P_h, |
| Alarm 1 Value | AL_1 | | Set the trigger point / value of Alarm 1 Range minimum to range maximum OFF disables the alarm. | 1373 |
| Alarm 1 Hysteresis | HYS1 | | The Alarm 1 switching point hysteresis 0 to full span. | 1 |
| Alarm 2 Type | AL2t | | Same options as Alarm 1 | P_Lo |
| Alarm 2 Value | AL_2 | | | -240 |
| Alarm 2 Hysteresis | HYS2 | | | 1 |
| Alarm Inhibit | inh, | nonE 1 2 1 2 | Inhibit alarms if active at power-up and on change in setpoint. None, Alarm 1, Alarm 2, Alarm 1 & 2. | nonE |
| Alarm Notification | NotE | nonE 1 2 1 2 | Enable alarm notification in the User Mode. Alternating indication -AL- shown when alarms are active. None, Alarm 1, Alarm 2, Alarm 1 & 2. | 1 2 |
| Alarm LED Indicator Selection | A. Ind | nonE 1 2 1 2 | Select the alarms that will show on the alarm LED indicator. None, Alarm 1, Alarm 2, Alarm 1 & 2. | 1 2 |
| Sensor Break Alarm | SbAc | On OFF | On = activates both alarms when a sensor break is detected. | OFF |

7.5 Soft Start feature (“Extrusion” version)

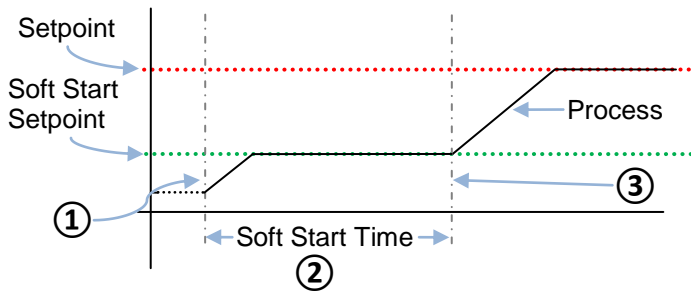

① At power on the unit will control to the Soft Start Setpoint, **SSSP**.

② Then remain at this value for the time defined by the Soft Start Time, **SSSt**.

During this period the control cycle time is a ¼ of the value entered and the heat power limit, **HPL**, is used.

③ When the soft start timer expires the unit returns to normal operation.

The unit controls to the normal setpoint and from this point the heat power limit is not used by the controller.

7.6 Non-linear Cooling feature (“Extrusion” version)

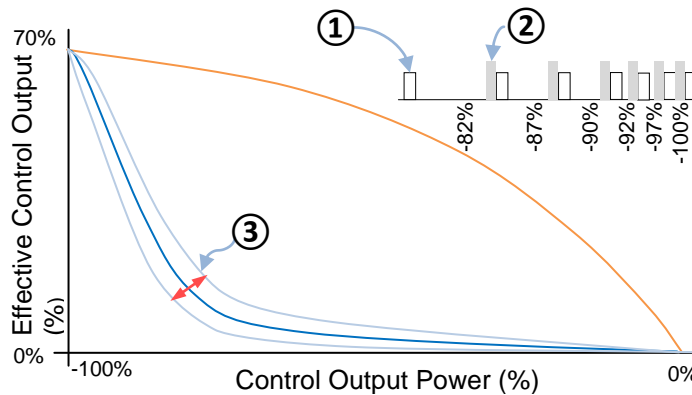

With non-linear cooling, e.g. when using water, the initial cooling effect can be stronger. For example, a change from 0% to -10% output power has more effect than say -70% to -80%. To compensate the cooling curve adjusts the output power so that the effective power over 0% to -70% is weaker.

① The length of time the output will be on for is set by the parameter **t.on**.

② The minimum time the output will be off for is set by the parameter **t.off**.

③ When **C.Adu** is set to a value greater than 0 the cooling is non-linear and the value adjusts the characteristics of the curve.

8 Manually Tuning Controllers

8.1 Single Control Tuning (PID with Heat Output only)

This simple technique balances the need to reach Setpoint quickly, with the wish to limit Setpoint overshoot at start-up or during process changes.

This method determines values for the Heat Proportional Band (H_Pb), Integral Time Constant ($Int.t$) and Derivative Time Constant ($Der.t$) that allow the PID control algorithm to give acceptable results in most applications that use a single control device.



This technique is suitable only for processes that are not harmed by large fluctuations in the process variable.

Check that the Setpoint Upper Limit ($SPUL$) and Setpoint Lower Limit ($SPLL$) are set to safe levels for your process. Adjust if required.

Set the Setpoint to the normal operating value for the process (or to a lower value if overshoots beyond this value might cause damage).

Select On-Off control (i.e. set $H_Pb = 0n.OF$).

Switch on the process. The process variable will oscillate about the Setpoint. Record the Peak-to-Peak variation (P) of the first cycle (i.e. the difference between the highest value of the first overshoot and the lowest value of the first undershoot), and the time period of the oscillation (T) in minutes. See the example diagram below.

Calculate the PID control parameters using the formula below. Input Span is the difference between Scale Range Lower Limit and Scale Range Upper Limit:

$$H_Pb = P$$

$$Int.t = T \text{ minutes}$$

$$Der.t = \text{minutes}$$

$$\frac{P}{\text{Input Span} \times \frac{T}{6}}$$

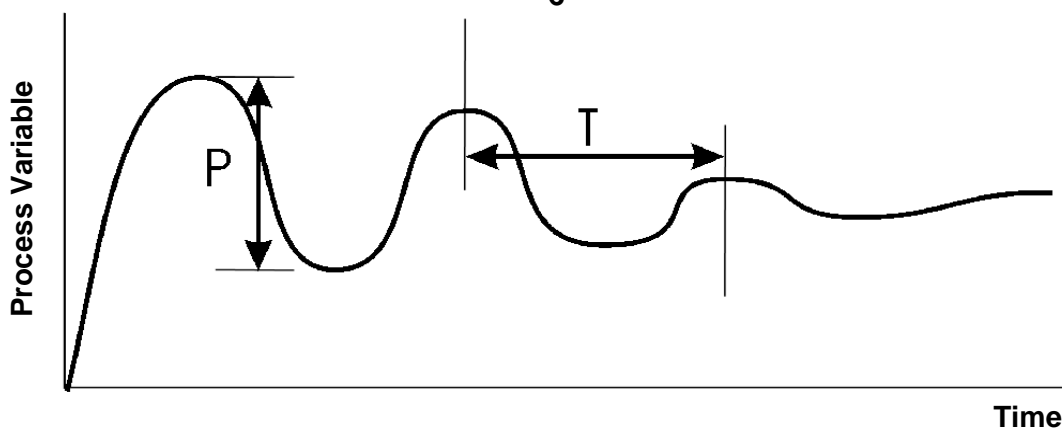

8.2 Manually Tuning PID

Dual Control Tuning (PID with Heat and Cool Outputs)

This simple technique balances the need to reach setpoint quickly, with the wish to limit setpoint overshoot at start-up and during process changes.

This method determines values for the Heat Proportional Band (H_Pb), Cool Proportional Band (C_Pb), Integral Time Constant (Int) and Derivative Time Constant ($dEr.t$) that allow the control algorithm to give acceptable results in most applications that use heating and cooling.



This technique is suitable only for processes that are not harmed by large fluctuations in the process variable.

Tune the controller using only the Heat Control output as described in the Single Control Tuning section above.

Set C_Pb to the same value as H_Pb and monitor the operation of the controller in dual control mode. If there is a tendency to oscillate as the control passes into the Cool Proportional Band, increase the value of C_Pb .

If the process appears to be over-damped in the region of the Cool Proportional Band, decrease the value of C_Pb .

When the PID tuning values have been determined, if there is a kick to the process variable as control passes from one output to the other, set the Overlap/Deadband parameter to a positive value to introduce some overlap. Adjust this value by trial and error until satisfactory results are obtained.

8.3 Manually Fine Tuning

A separate cycle time adjustment parameter is provided for each time proportioning control output.



Adjusting the cycle time affects the controllers operation; a shorter cycle time gives more accurate control but electromechanical components such as relays have a reduced life span.

Increase the width of the proportional band if the process overshoots or oscillates excessively.

Decrease the width of the proportional band if the process responds slowly or fails to reach Setpoint.

Increase the automatic reset (integral) until the process becomes unstable, then decrease until stability has been restored.



Allow enough time for the controller and process to adjust.

Initially add rate at a value between $1/4^{\text{th}}$ and $1/10^{\text{th}}$ of the automatic reset value.

Decrease Rate if the process overshoots/undershoots or oscillates excessively.

After making all other adjustments, if an offset exists between the Setpoint and the process variable use the Bias (manual reset) to eliminate the error:

Below Setpoint - use a larger bias value

Above Setpoint - use a smaller bias value

9 Calibration Mode

It is possible to calibrate the controller to compensate for sensor errors and other tolerance errors in the system. This is achieved using the calibration mode. The calibration mode allows an offset to be applied in one of two ways. The method used will be dependent on the process application.

9.1 Single point calibration (PV Offset)

This is a 'zero offset' applied to the process variable across the entire span. Positive values are added to the reading, negative values are subtracted. It can be used if the error is constant across the range, or the user is only interested in a single critical value.

To use, select Single Point Calibration from the input calibration menu, and simply enter a value equal, but opposite to the observed error to correct the reading.

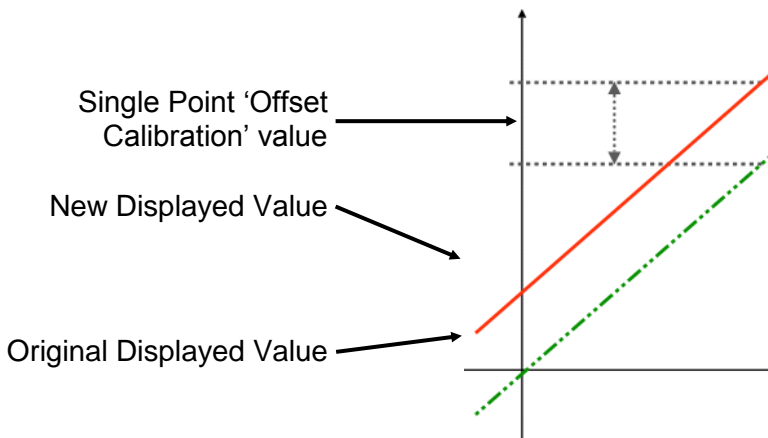

This example shows a positive offset value.

For example:
If the process displays 27.8 when it should read 30, The error is -2.2 so an applied offset of +2.2 would change the displayed value to 30.

The same offset is applied to all values, so at 100.0 the new displayed value would be 102.2.

9.2 Two Point Calibration

This method is used where an error is not constant across the range. Separate offsets are applied at two points in the range to eliminate both “zero” and “span” errors.

To use:

1. Measure and record the error at a low point in the process.
2. Measure and record the error at a high point in the process.
3. Go to the first two point input calibration screen.
 - a. Enter the desired low point value as the Calibration Low PV value.
 - b. Enter an equal, but opposite value to the observed error as the Calibration Low Offset to correct the error at the low point.
4. Go to the second two point input calibration screen.
 - a. Enter the desired high point as the Calibration High PV value.
 - b. Enter an equal, but opposite value to the observed error as the Calibration High Offset to correct the error at the high point.

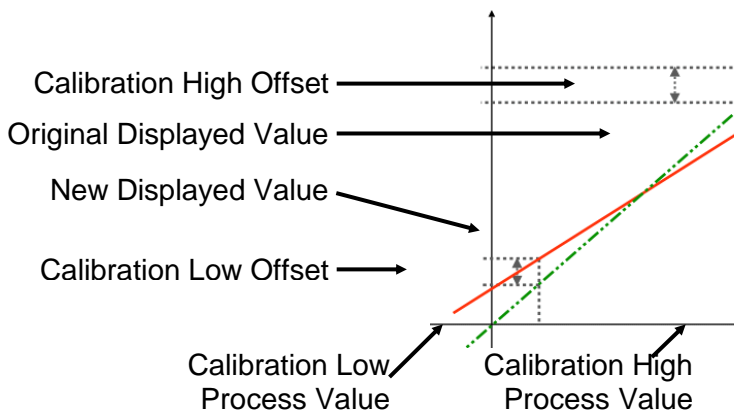

This example shows a positive Low Offset and a negative High Offset. For example:

If the process displays a low end error where +0.5 displays as 0.0, an offset of +0.5 corrects the value to +0.5

A high end value of 100.0 with a -1.7 offset would read 98.3. There is a linear relationship between these two calibration points.



CAUTION: Choose values as near as possible to the bottom and top of your usable span to achieve maximum calibration accuracy. The effect of any error can grow at values beyond the chosen calibration points.

10 Serial Communications

10.1 Supported Protocol

The unit supports Modbus RTU protocol through the RS485 interface.
For a complete description of the Modbus protocol refer to the description provided at <http://www.modbus.org/>

10.2 RS485 Configuration

The RS485 address, bit rate and character format are configured via the front panel from the Communications Sub-menu.

| | |
|--------------------------|--------------------------------------|
| Data rate: | 4800, 9600, 19200 or 38400 bps |
| Parity: | None (default), Even or Odd |
| Character format: | Always 8 bits per character (1 byte) |
| Device Address: | See RS485 Device Addressing |



For successful communication the master device must have matching communications settings.

10.3 RS485 Device Addressing

The instrument must be assigned a unique device address in the range 1 to 255. This address is used to recognise Modbus Queries intended for this instrument. With the exception of globally addressed broadcast messages, the instrument ignores Modbus Queries that do not match the address that has been assigned to it.

The instrument will accept broadcast messages (global queries) using device address 0 no matter what device address is assigned. No response messages are returned for globally addressed Queries.

10.4 Link Layer

A Query (or command) is transmitted from the Modbus Master to the Modbus Slave. The slave instrument assembles the reply to the master.

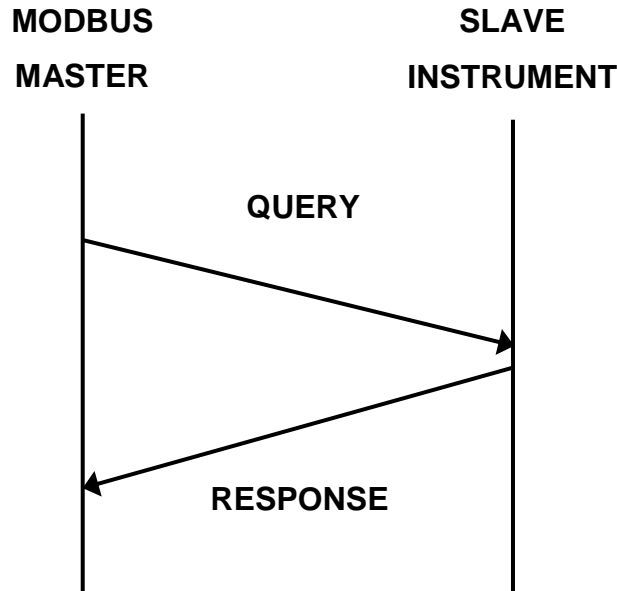

A message for either a QUERY or RESPONSE is made up of an inter-message gap followed by a sequence of data characters. The inter-message gap is at least 3.5 data character times - the transmitter must not start transmission until 3 character times have elapsed since reception of the last character in a message, and must release the transmission line within 3 character times of the last character in a message.



Three character times is approximately 0.75ms at 38400 bps, 1.5ms at 19200 bps, 3ms at 9600 bps and 6ms at 4800bps.

Data is encoded for each character as binary data, transmitted LSB first. For a QUERY the address field contains the address of the slave destination. The slave address is given together with the Function and Data fields by the Application layer. The CRC is generated from the given address, function and data characters. For a RESPONSE the address field contains the address of the responding slave. The Function and Data fields are generated by the slave application. The CRC is generated from the address, function and data characters. The standard MODBUS RTU CRC-16 calculation employing the polynomial $2^{16}+2^{15}+2^2+1$ is used.

| | | | | |
|-------------------|------------------------|-------------------------|-----------------------------|---------------------------|
| Inter-message gap | Address 1 character | Function 1 character | Data <i>n</i> characters | CRC Check 2 characters |
|-------------------|------------------------|-------------------------|-----------------------------|---------------------------|

10.5 Supported Modbus Functions

Modbus defines several function types. The following types are supported by this instrument:

| Function Code decimal (hex) | Modbus Meaning | Description |
|-----------------------------|--------------------------------|---|
| 03 (0x03) 04 (0x04) | Read Holding / Input registers | Read current binary value of specified number of parameters at given address. Up to 64 parameters can be accessed with one query. |
| 08 (0x08) | Diagnostics | Used for loopback test only to check the communications work. |
| 16 (0x10) | Write Multiple Registers | Writes up to 253 bytes of data to the specified address range. |

10.6 Function Descriptions

The following is interpreted from the Modbus Protocol Description obtainable from <http://www.modbus.org/>.

In the function descriptions below, the preceding device address value is assumed, as is the correctly formed two-byte CRC value at the end of the QUERY and RESPONSE frames.

Function 03 / 04 - Read Holding/Input Registers

Reads current binary value of data at the specified word addresses.

| QUERY | | | | |
|----------|---------------------------------|----|-----------------|----|
| Function | Address of 1 st Word | | Number of Words | |
| 03 / 04 | HI | LO | HI | LO |

| RESPONSE | | | | | |
|----------|-----------------|------------|----|-----------|----|
| Function | Number of Bytes | First Word | | Last Word | |
| 03 / 04 | n | HI | LO | HI | LO |

In the response the “Number of Bytes”, n, indicates the number of data bytes read from the instrument. E.g. if 5 words are read, the count will be 10 (A hex). The maximum number of words that can be read is 64. If a parameter does not exist at one of the addresses read, then a value of 0000h is returned for that word.

Function 08 - Loopback Diagnostic Test

| QUERY | | | | |
|----------|-----------------|-------|-------|----|
| Function | Diagnostic Code | | Value | |
| 08 | HI =00 | LO=00 | HI | LO |

| RESPONSE | | | | |
|----------|--------------|-------|-------|----|
| Function | Sub-function | | Value | |
| 08 | HI=00 | LO=00 | HI | LO |



The Response normally returns the same data as the loopback query and so can be used to test the communications. Other Diagnostic Codes are not supported.

11 Modbus Addresses

11.1 Input parameters

| Parameter Name | Modbus Address (Dec) | Modbus Address (Hex) | Access R/W | Notes | Default | |
|-------------------------|----------------------|----------------------|------------|----------------------------|----------------|----|
| Process Variable | 1070 | 42E | RO | | n/a | |
| Input Filter | 1004 | 3EC | R/W | 0 to 100 seconds | 0.5s | |
| CJC Enable | 1006 | 3EE | R/W | 0 = Off 1 = On | 1 | |
| Input units | 1005 | 3ED | R/W | 0 = Deg C 1 = Deg F | 0 | |
| Decimal point position | 1003 | 3EB | R/W | Value | Range | 0 |
| | | | | 0 | XXXX 0 DP | |
| | | | | 1 | XXX.X 1 DP | |
| | | | | 2 | XX.XX 2 DP | |
| | | | | 3 | X.XXX 3 DP | |
| Scale range lower limit | 1002 | 3EA | R/W | | -200 | |
| Scale range upper limit | 1001 | 3E9 | R/W | | 1372 | |
| Input Status | 1071 | 42F | RO | | n/a | |
| Input Range | 1000 | 3E8 | R/W | Value | Range | 40 |
| | | | | 0 | J Thermocouple | |
| | | | | 1 | K Thermocouple | |
| | | | | 2 | PT100 | |
| | | | | 3 | B Thermocouple | |
| | | | | 4 | C Thermocouple | |
| | | | | 5 | L Thermocouple | |
| | | | | 6 | N Thermocouple | |
| | | | | 7 | R Thermocouple | |
| | | | | 8 | S Thermocouple | |
| | | | | 9 | T Thermocouple | |
| | | | | 10 | 0 – 20mA | |
| | | | | 11 | 4 – 20mA | |
| | | | | 12 | 0 – 50mA | |
| | | | | 13 | 10 – 50mA | |
| | | | | 14 | 0 – 5V | |
| | | | | 15 | 1 – 5V | |
| | | | | 16 | 0 – 10V | |
| 17 | 2 – 10V | | | | | |
| Sensor break status | 1072 | 430 | RO | 0 = Ok 1 = Sensor break | NA | |
| Under range status | 1073 | 431 | RO | 0 = Ok 1 = Under range | NA | |
| Over range status | 1074 | 432 | RO | 0 = Ok 1 = Over range | NA | |

11.2 User Calibration

| Parameter Name | Modbus Address (Dec) | Modbus Address (Hex) | Access R/W | Notes | Default |
|------------------------|----------------------|----------------------|------------|---|---------------|
| Single Point Offset | 1601 | 641 | R/W | +/- Span | 0 |
| Low calibration point | 1602 | 642 | R/W | Input range maximum to input range minimum. | range minimum |
| Low offset | 1603 | 643 | R/W | +/- Span | 0 |
| High calibration point | 1604 | 644 | R/W | Input range maximum to input range minimum. | range minimum |
| High offset | 1605 | 645 | R/W | +/- Span | 0 |

11.3 Auto Calibration

| Parameter Name | Modbus Address (Dec) | Modbus Address (Hex) | Access R/W | Notes | Default |
|-------------------------|----------------------|----------------------|------------|---|---------|
| 50mV Auto Calibration | 1700 | 6A4 | WO | Write 0xCAFE to start auto calibration | NA |
| 10V Auto Calibration | 1701 | 6A5 | WO | Write 0xCAFE to start auto calibration | NA |
| 20mA Auto Calibration | 1702 | 6A6 | WO | Write 0xCAFE to start auto calibration | NA |
| RTD Auto Calibration | 1703 | 6A7 | WO | Write 0xCAFE to start auto calibration | NA |
| CJC Auto Calibration | 1704 | 6A8 | WO | Write 0xCAFE to start auto calibration | NA |
| Auto Calibration Status | 1770 | 6EA | RO | 0x0000 = Calibration Fail 0xCAFE = Calibration Busy 0xFFFF = Calibration Pass | NA |

11.4 Output Option 1 parameters

| Parameter Name | Modbus Address (Dec) | Modbus Address (Hex) | Access R/W | Notes | Default |
|---------------------|----------------------|----------------------|------------|--|---------|
| Output Usage | 1100 | 44C | R/W | 0 = Heat Output 1 = Cool Output 2 = Non-Linear Cooling 3 = Alarm 1 4 = Alarm 2 5 = Alarm 1 or Alarm 2 | 1 |
| Output LED Invert | 1101 | 44D | R/W | 0 = Sync with output 1 = Opposite to output | 0 |
| Output Alarm Action | 1102 | 44E | R/W | 0 = Direct 1 = Reverse | 0 |

| Parameter Name | Modbus Address (Dec) | Modbus Address (Hex) | Access R/W | Notes | Default |
|--------------------|----------------------|----------------------|------------|-------------------|---------|
| Output Alarm Latch | 1103 | 44F | R/W | 0 = Off 1 = On | 0 |

11.5 Output Option 2 parameters

| Parameter Name | Modbus Address (Dec) | Modbus Address (Hex) | Access R/W | Notes | Default |
|---------------------|----------------------|----------------------|------------|--|---------|
| Output Usage | 1120 | 460 | R/W | 0 = Heat Output 1 = Cool Output 2 = Non-Linear Cooling 3 = Alarm 1 4 = Alarm 2 5 = Alarm 1 or Alarm 2 | 1 |
| Output LED Invert | 1121 | 461 | R/W | 0 = Sync with output 1 = Opposite to output | 0 |
| Output Alarm Action | 1122 | 462 | R/W | 0 = Direct 1 = Reverse | 0 |
| Output Alarm Latch | 1123 | 463 | R/W | 0 = Off 1 = On | 0 |

11.6 Output Option 3 parameters

| Parameter Name | Modbus Address (Dec) | Modbus Address (Hex) | Access R/W | Notes | Default |
|---------------------|----------------------|----------------------|------------|--|---------|
| Output Usage | 1130 | 46A | R/W | 0 = Heat Output 1 = Cool Output 2 = Non-Linear Cooling 3 = Alarm 1 4 = Alarm 2 5 = Alarm 1 or Alarm 2 | 1 |
| Output LED Invert | 1131 | 46B | R/W | 0 = Sync with output 1 = Opposite to output | 0 |
| Output Alarm Action | 1132 | 46C | R/W | 0 = Direct 1 = Reverse | 0 |
| Output Alarm Latch | 1133 | 46D | R/W | 0 = Off 1 = On | 0 |

11.7 Control

| Parameter Name | Modbus Address (Dec) | Modbus Address (Hex) | Access R/W | Notes | Default |
|-------------------------------|----------------------|----------------------|------------|--|---------|
| Heat Proportional Band | 1302 | 516 | R/W | 0 (ON/Off) or 0.1 to 9999 | 10 |
| Cool Proportional Band | 1303 | 517 | R/W | 0 (ON/Off) or 0.1 to 9999 | 10 |
| Integral | 1304 | 518 | R/W | 0 (Off) or 1 to 9999 | 75 |
| Derivative | 1305 | 519 | R/W | 0 (Off) or 1 to 9999 | 15 |
| Overlap | 1306 | 51A | R/W | -20% to 20% of primary and secondary proportional band | 0 |
| Manual Reset | 1307 | 51B | R/W | 0% (-100% for dual control) to 100% | |
| Differential | 1308 | 51C | R/W | 0.1 | |
| Heat Power Limit | 1311 | 51F | R/W | 0 to 100 | 100 |
| Cool Power Limit | 1312 | 520 | R/W | 0 to 100 | 100 |
| Control Enable/Disable | 1375 | 55F | R/W | 0 = Control Disabled 1 = Control Enabled | 1 |
| Control Enable state | 1376 | 560 | RO | 0 = Control Disabled 1 = Control Enabled | NA |
| Manual Power Enable | 1315 | 523 | R/W | 0 = Automatic Control 1 = Manual Control | 0 |
| Combined Power | 1316 | 524 | RO | -100 to 100 | NA |
| Heat Power | 1370 | 55A | RO | 0 to 100 | NA |
| Cool Power | 1371 | 55B | RO | 0 to 100 | NA |
| Loop Alarm Status | 1372 | 55C | RO | 0 = Inactive 1 = Active | NA |
| Power-up Action | 1377 | 561 | R/W | 0 = As switch off 1 = Always power on | |
| Heat Cycle Time | 1378 | 562 | R/W | | |
| Cool Cycle Time | 1379 | 563 | R/W | | |
| Non-Linear Cooling parameters | | | | | |
| Parameter Name | Modbus Address (Dec) | Modbus Address (Hex) | Access R/W | Notes | Default |
| Minimum Cooling Temperature | 1380 | 564 | R/W | Range minimum to range maximum | 120 |
| Impulse Length | 1381 | 565 | R/W | 0.01 to 9999 | 0.1 |
| Minimum Off Time | 1382 | 566 | R/W | 0.1 to 9999 | 2.0 |
| Cooling Adjust | 1383 | 567 | R/W | 0.0 to 9999 | 0.5 |
| Tuning Type | 1384 | 568 | R/W | 0 = No 1 = Yes | 0 |

11.8 Setpoint

| Parameter Name | Modbus Address (Dec) | Modbus Address (Hex) | Access R/W | Notes | Default |
|----------------------------|----------------------|----------------------|------------|-------------------|---------------|
| Setpoint | 1200 | 4B0 | R/W | | Range minimum |
| Setpoint maximum | 1201 | 4B1 | R/W | | Range minimum |
| Setpoint Minimum | 1202 | 4B2 | R/W | | Range minimum |
| Setpoint ramp rate | 1204 | 4B4 | R/W | | Off |
| Actual Setpoint | 1270 | 4F6 | RO | | NA |
| Timer Enable | 1275 | 4FB | R/W | 0 = Off 1 = On | 0 |
| Timer Delay Time | 1276 | 4FC | R/W | 0 to 9999 minutes | Off |
| Timer On Time | 1277 | 4FD | R/W | 0 to 9999 minutes | Off |
| Timer remaining delay time | 1278 | 4FE | RO | | NA |
| Timer remaining on time | 1279 | 4FF | RO | | NA |

11.9 Alarm parameters

| Parameter Name | Modbus Address (Dec) | Modbus Address (Hex) | Access R/W | Notes | Default |
|--------------------|----------------------|----------------------|------------|--|---------|
| Alarm 1 Type | 1400 | 578 | R/W | 0 = None 1 = High Alarm 2 = Low Alarm 3 = Deviation 4 = Band | 1 |
| Alarm 1 Value | 1402 | 57A | R/W | Limited by the input range maximum and minimum. | Off |
| Alarm 1 Hysteresis | 1403 | 57B | R/W | Limited by the span of the input range | 10 |
| Alarm 2 Type | 1404 | 57C | R/W | 0 = None 1 = High Alarm 2 = Low Alarm 3 = Deviation 4 = Band | 2 |
| Alarm 2 Value | 1406 | 57E | R/W | Limited by the input range maximum and minimum. | Off |
| Alarm 2 Hysteresis | 1407 | 57F | R/W | Limited by the span of the input range | 10 |
| Alarm Notification | 1408 | 580 | R/W | 0 = None 1 = Alarm 1 2 = Alarm 2 3 = Alarm 1 and Alarm 2 | 3 |

| Parameter Name | Modbus Address (Dec) | Modbus Address (Hex) | Access R/W | Notes | Default |
|-------------------------------|----------------------|----------------------|------------|---|---------|
| Sensor Break Activates alarms | 1409 | 581 | R/W | 0 = Off 1 = On | 0 |
| Alarm Inhibit | 1410 | 582 | R/W | 0 = None 1 = Alarm 1 2 = Alarm 2 3 = Both Alarms | 0 |
| Alarm LED Disabled | 1411 | 583 | R/W | 0 = Off 1 = On | 1 |
| Alarm 1 Status | 1470 | 5BE | RO | 0 = Inactive 1 = Active | NA |
| Alarm 2 Status | 1471 | 5BF | RO | 0 = Inactive 1 = Active | NA |

11.10 Display parameters

| Parameter Name | Modbus Address (Dec) | Modbus Address (Hex) | Access R/W | Notes | Default |
|-------------------------------|----------------------|----------------------|------------|---------------------------|---------|
| Setup Mode Lock Code | 1804 | 70C | R/W | Default 10 | 10 |
| Advanced Mode Lock Code | 1803 | 70B | R/W | Default 10 | 20 |
| Basic Setpoint Control Enable | 1805 | 70D | R/W | 0 = Standard 1 = Basic | 0 |

11.11 Communications

| Parameter Name | Modbus Address (Dec) | Modbus Address (Hex) | Access R/W | Notes | Default |
|----------------|----------------------|----------------------|------------|--|---------|
| Modbus Address | 1500 | 5DC | R/W | 1 to 255 | 1 |
| Parity | 1501 | 5DD | R/W | 0 = None 1 = Even 2 = Odd | 0 |
| Baud rate | 1502 | 5DE | R/W | 0 = 1200 1 = 2400 2 = 4800 3 = 9600 4 = 19200 5 = 38400 | 4 |



11.12 Manufacturing Information

| Parameter Name | Modbus Address (Dec) | Modbus Address (Hex) | Access R/W | Notes | Default |
|------------------------|----------------------|----------------------|------------|-------|---------|
| Manufacturing ID | 500 | 1F4 | Read Only | | |
| Equipment ID | 501 | 1F5 | Read Only | | NA |
| Serial Number Low | 502 | 1F6 | Read Only | | NA |
| Serial Number Mid | 503 | 1F7 | Read Only | | NA |
| Serial Number High | 504 | 1F8 | Read Only | | NA |
| Date Of Manufacture | 505 | 1F9 | Read Only | | NA |
| Product Revision Level | 506 | 1FA | Read Only | | NA |
| Firmware Version | 507 | 1FB | Read Only | | NA |
| Product ID | 508 | 1FC | Read Only | | NA |

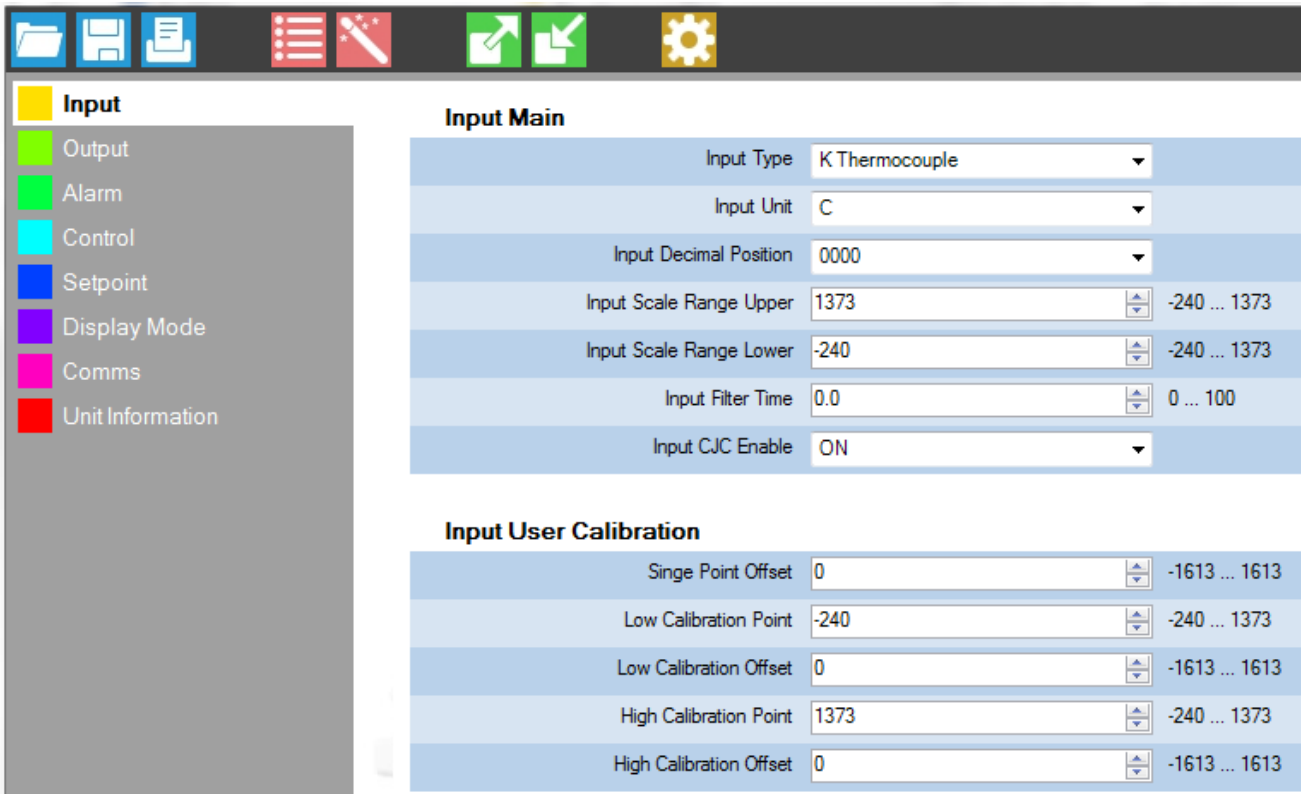
12 Device Configurator PC Software



12.1 Features

- Device menus are clearly laid out on the left with the relevant parameters on the right.
- Parameter sets can be Loaded, Saved or Printed using the  icons.
- Parameters can be Uploaded to and Downloaded from the device using the  icons.
- Setup wizard simplifies the setting up of the device.
- Can be used via the dedicated configuration port on the bottom or via the optional RS485 if fitted.

Please note the dedicated configuration socket is similar to a micro USB socket but should never be directly connected to a USB port or USB charger. Use of this socket requires the USB port to configuration socket adaptor, available from your supplier.

12.2 Brief Guide to Starting the Software

Make sure you select the correct model when you start the software:



MV-160M-RR00-20

Model Type: 1/16 DIN (16)
Variant: Standard (0)
Supply Voltage: 100-240V AC (M)
Output 1: Relay (R)
Output 2: Relay (R)
Output 3: None (0)
Option A: None (0)
Display: Upper Red, Lower Green
Manual: No Manual (0)
Certification: CE, UL (U)
Packing Option: Single Pack (0)

MaxVU - Standard
Version: 0.1
Standard MaxVU Temperature Controller device.

MaxVU - Plastics
Version: 0.1
Plastics MaxVU Temperature Controller device.

Load

Certification
Packing Option

Read from Device



Click on **Read from Device** button on the bottom left. The Configuration Port option requires a special cable available from your supplier and is only available RS485 if fitted.

Select Units communication port
Configuration Port

Select Units communication port
RS485 Port

Current Settings

Available Ports: COM7
Address: 1
Baudrate: 19200
Databits: 8
Parity: None

Cancel OK

13 Thermocouple Identification and Ranges

Thermocouples are identified by wire colour, and where possible, the outer insulation as well. There are several standards in use throughout the world.

| Type | | International IEC584-3 | USA ANSI MC 96.1 | British BS1843 | French NFC 42-324 | German DIN 43710 |
|--------|----|------------------------|------------------|----------------|-------------------|------------------|
| J | +* | Black Black | White Black | Yellow Black | Yellow Black | Red Blue |
| | - | White Black | Red Black | Blue Black | Black Black | Blue Blue |
| T | + | Brown Brown | Blue Blue | White Blue | Yellow Blue | Red Brown |
| | - | White Brown | Red Blue | Blue Blue | Blue Blue | Brown Brown |
| K | + | Green Green | Yellow Yellow | Brown Red | Yellow Yellow | Red Green |
| | -* | White Green | Red Yellow | Blue Red | Purple Yellow | Green Green |
| N | + | Pink Pink | Orange Orange | Orange Orange | | |
| | - | White Pink | Red Orange | Blue Orange | | |
| B | + | Grey Grey | Grey Grey | | | Red Grey |
| | - | White Grey | Red Grey | | | Grey Grey |
| R & S | + | Orange Orange | Black Green | White Green | Yellow Green | Red White |
| | - | White Orange | Red Green | Blue Green | Green Green | White White |
| C (W5) | + | | White White | | | |
| | - | | Red White | | | |

Note:
* = Wire is magnetic

| | |
|--------|--------|
| + Wire | Sheath |
| - Wire | |

| Type | Ranges Supported | |
|----------------|---------------------------------|---------------------------------------|
| J thermocouple | -200 to 1200°C (-328 to 2192°F) | -128.8 to 537.7°C (-199.9 to 999.9°F) |
| K thermocouple | -240 to 1373°C (-400 to 2503°F) | -128.8 to 537.7°C (-199.9 to 999.9°F) |
| PT100 | -199 to 800°C (-328 to 1472°F) | -128.8 to 537.7°C (-199.9 to 999.9°F) |
| B thermocouple | 100 to 1824°C (211 to 3315°F) | |
| C thermocouple | 0 to 2320°C (32 to 4208°F) | |
| L thermocouple | 0 to 762°C (32 to 1403°F) | 0.0 to 537.7°C (32.0 to 999.9°F) |
| N thermocouple | 0 to 1399°C (32 to 2551°F) | |
| R thermocouple | 0 to 1795°C (32 to 3198°F) | |
| S thermocouple | 0 to 1762°C (32 to 3204°F) | |
| T thermocouple | -240 to 400°C (-400 to 752°F) | -128.8 to 400°C (-199.9 to 752.0°F) |

14 Specifications

| Universal Input | |
|--------------------------|---|
| Thermocouple Calibration | +/- 0.25% of full range, +/- 1LSD (+/- 1°C for Thermocouple CJC). BS4937, NBS125 & IEC584. |
| PT100 Calibration | +/- 0.25% of full range, +/- 1LSD. BS1904 & DIN43760 (0.00385 $\Omega/\Omega/^\circ\text{C}$). |
| DC Calibration | +/- 0.2% of full range, +/- 1LSD. |
| Sampling Rate | 4 per second. |
| Impedance | >10M Ω resistive, except DC mA (5 Ω) and V (47k Ω). |
| Sensor Break Detection | Thermocouple, RTD, 4 to 20mA, 2 to 10V and 1 to 5V ranges only. Control outputs turn off. |
| Isolation | Isolated from all outputs (except SSR driver) by at least BASIC isolation. The input must not be connected to operator accessible circuits if relay outputs are connected to a hazardous voltage source. Supplementary insulation or input grounding would then be required. Isolated from Mains Power Input by basic isolation. |

| Outputs | |
|-------------------------------|---|
| RELAYS (OPTIONAL) | |
| Contacts | SPST Form A relay; current capacity 2A at 250VAC. |
| Lifetime | >150,000 operations at rated voltage/current, resistive load. |
| Isolation | Basic Isolation from universal input and SSR outputs. |
| SSR Drivers (OPTIONAL) | |
| Drive Capability | SSR drive voltage >10V at 20mA |
| Isolation | Not isolated from the input or other SSR driver outputs. |

| Serial Communications (Optional) | |
|----------------------------------|---|
| Physical | RS485, at 1200, 2400, 4800, 9600, 19200 or 38400 baud. |
| Protocols | Modbus RTU. |
| Isolation | Basic safety isolation from Universal input and SSR. Basic safety isolation to Mains and Relay Circuits. |

| Operating Conditions | |
|------------------------|---|
| Usage | For indoor use only, mounted in suitable enclosure. |
| Ambient Temperature | 0°C to 55°C (Operating), -20°C to 80°C (Storage). |
| Relative Humidity | 20% to 95% non-condensing. |
| Altitude | <2000m |
| Supply Voltage & Power | 100 to 240VAC +/- 10% 50/60Hz 7.5VA (for mains powered versions) or 24VAC +10 / -15% 50/60Hz 7.5VA or 24VDC +10 / -15% 5W (for low voltage versions). |

| Environmental | |
|-----------------------|--|
| Standards | CE |
| EMI | Complies with EN61326 (Susceptibility & Emissions). |
| Safety Considerations | Complies with EN61010-1 Pollution Degree 2, Installation Category II. |
| IP Rating (Sealing) | Front to IP65 when correctly mounted. Rear of panel to IP20. |

| Physical | |
|--------------------|---|
| Front Bezel Size | 1/16 Din = 48 x 48 mm 1/8 Din = 48 x 96 mm |
| Depth Behind Panel | 67mm with sealing gasket fitted. |
| Weight | 0.20kg maximum |

15 Glossary

Actual Setpoint

Actual Setpoint is the current effective value of the Setpoint. This may be different to the Active Setpoint's target value if the Setpoint is currently ramping. The actual Setpoint will rise or fall at the ramp-rate set, until it reaches the target Setpoint value. Also refer to *Active Setpoint*, *Setpoint*, *Setpoint Ramp Enable*.

Alarm Hysteresis

An adjustable band on the "safe" side of an alarm point, through which the process variable must pass before the alarm will change state, as shown in the diagram below.

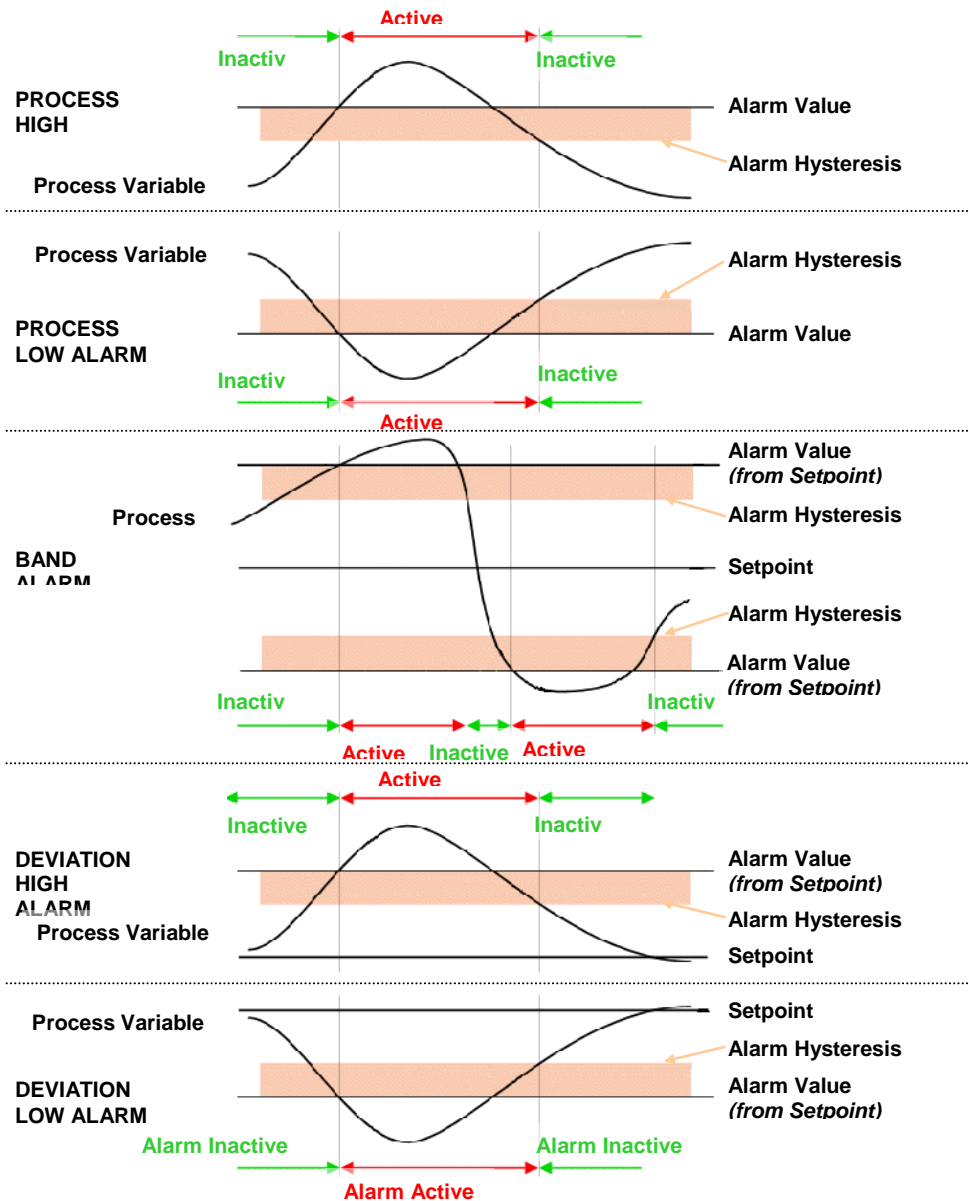

E.g. a high alarm's hysteresis band is below the high alarm value, and a low alarm's hysteresis is above the low alarm value. Also refer to *Alarm Operation*.

Alarm Operation

The different alarm types are shown below, together with the action of any outputs. Also refer to *Alarm Hysteresis*, *Alarm Inhibit*, *Band Alarm*, *Deviation Alarm*, *Latching Relay*, *Logical Alarm Combinations*, *Loop Alarm*, *Process High Alarm* and *Process Low Alarm*.

| | | | | |
|-----------------------------------|------------------------|-------------------------|-------------------------|------------------------|
| Process High Alarm | | Output Off Alarm Off | Output On Alarm On | |
| Direct-Acting | | Alarm Value | Process Variable | |
| Process High Alarm | | Output On Alarm Off | Output Off Alarm On | |
| Reverse-Acting | | Alarm Value | Process Variable | |
| Process Low Alarm | | Output On Alarm On | Output Off Alarm Off | |
| Direct-Acting | | Alarm Value | Process Variable | |
| Process Low Alarm | | Output Off Alarm On | Output On Alarm Off | |
| Reverse-Acting | | Alarm Value | Process Variable | |
| Band Alarm | Output On Alarm On | Output Off Alarm Off | Output Alarm On | |
| Direct-Acting | Alarm Value | Alarm Value | Process Variable | |
| Band Alarm | Output Off Alarm On | Output On Alarm Off | Output Off Alarm On | |
| Reverse-Acting | Alarm Value | Alarm Value | Process Variable | |
| Deviation High Alarm (+ve values) | | | Output Off Alarm Off | Output Alarm On |
| Direct-Acting | | | Alarm Value | Process Variable |
| Deviation High Alarm (+ve values) | | | Output On Alarm Off | Output Off Alarm On |
| Reverse-Acting | | | Alarm Value | Process Variable |
| Deviation Low Alarm (-ve values) | Output On Alarm On | Output Off Alarm Off | | |
| Direct-Acting | | Alarm Value | | Process Variable |
| Deviation Low Alarm (-ve values) | Output Off Alarm On | Output On Alarm Off | | |
| Reverse-Acting | | Alarm Value | | Process Variable |
| | | | Setpoint | |

Alarm Inhibit

Inhibits an alarm at power-up or when the controller Setpoint is changed, until that alarm goes inactive. The alarm operates normally from that point onwards.

Also refer to Alarm Operation.

Automatic Reset (Integral)

Used to automatically bias the proportional output(s) to compensate for process load variations. It is adjustable in the range 1 seconds to 99 minutes 59 seconds per repeat and OFF (value greater than 99 minutes 59 seconds - display shows **OFF**).

Decreasing the time increases the Integral action. This parameter is not available if the primary output is set to On-Off.

Also refer to Heat Proportional Band, Cool Proportional Band, Rate, PID, and Tuning.

Auto-Tune

Refer to Pre-Tune and Tune at Setpoint.

Band Alarm Value

This parameter is applicable only if an Alarm is selected to be a Band Alarm. It defines a band of process variable values, centred on the current actual Setpoint value. If the process variable value is outside this band, the alarm will be active. This parameter may be adjusted from 1 to full span from the Setpoint.

Also refer to Alarm Operation and Input Span.

Basic Setpoint Control

When Basic Setpoint Control is enabled the user can only change the setpoint or the power from the User mode screen. To change other settings the user must enter the Advanced Configuration Mode.

Bias (Manual Reset)

Used to manually bias the proportional output(s) to compensate for process load variations. Bias is expressed as a percentage of output power and is adjustable in the range 0% to 100% (for Heat Output alone) or -100% to +100% (for both Primary and Cool Outputs). This parameter is not applicable if the Primary output is set to ON/OFF control mode. If the process settles below Setpoint use a higher Bias value to remove the error, if the process variable settles above the Setpoint use a lower Bias value. Lower Bias values will also help to reduce overshoot at process start up.

Also refer to ON/OFF Control and PID.

Bumpless Transfer

A method used prevent sudden changes to the output power level when switching between Automatic and Manual control modes. During a transition from Automatic to Manual, the initial Manual Power value will be set to equal the previous automatic mode value. The user can then adjust the value as required. During a transition from Manual to Automatic, the initial Automatic Power value will be set to equal the previous manual mode value. The correct power level will gradually applied by the control algorithm at a rate dependant on the integral action resulting from the Automatic Reset time. Since integral action is essential to Bumpless Transfer, this feature is not available if Automatic Reset is turned off.

Also refer to Automatic Reset (Integral) and Manual Mode

Calibration - 2 Point (High/Low PV Offset)

Two point calibration uses two separate points of reference, usually at the process high and low operating limits to determine the required offsets. These offsets are used to rescale all readings over the full range of the controller minimising inaccuracies in the input reading.

Refer to User Calibration Type.

Calibration - Single Point (PV Offset)

Single point calibration uses a single point of reference, usually at the operating process value to determine the required calibration offset. This offset is then applied to all measurements throughout the span of the controller.

Refer to User Calibration Type.

Control Type

This is selected by using the Out 1, Out 2 and Out 3 parameters. Heat is reverse action and Cool is direct action as more cooling is required when the temperature (PV) rises.

Refer to PID, Heat Proportional Band, Process Variable and Cool Proportional Band.

Controller

An instrument that can control a Process Variable, using either PID or On-Off control methods. Alarm outputs are also available that will activate at preset PV values, as are other options and Serial Communications.

Refer to Alarm Operation, Indicator, Limit Controller, On-Off Control, PID, Process Variable and Serial Communications.

Cool Proportional Band

The portion of the input span over which the Cool Output power level is proportional to the process variable value. It may be adjusted in range units equivalent to 0.5% to 999.9%, or ON.OFF of the input span. The Control action for the Cool Output is always the opposite of the Heat output.

The Cool Proportional Band is only applicable when the Cool Output is used.

Refer to Control Type, On-Off Control, Input Span, Overlap/Deadband, PID, Heat Proportional Band and Tuning.

Cycle Time

For time proportioning outputs, cycle time is used to define the time period over which the average on vs. off time is equal to the required PID output level. *HcYc* and *CcYc*, are available when the Heat or Cool outputs are defined as time proportioning output types. The permitted range of value is 0.1 to 512 seconds in 0.1s steps. Shorter cycle times will give better control, but at the expense of reduce life when used with an electromechanical control device (e.g. relays or solenoid valves).

Also refer to PID and Time Proportioning.

Deadband

- Refer to *Overlap/Deadband*.

Derivative

Refer to *Rate*.

Deviation Alarm

This is applicable only if Alarm is selected to be Deviation Alarm. A positive value (Deviation High) sets the alarm point above the current actual Setpoint, a negative value (Deviation Low) sets it below. If the process variable deviates from the Setpoint by a margin greater than this value, alarm 1 becomes active.

Also refer to Alarm Operation.

Differential (On-Off Hysteresis)

A switching differential used when one or both control outputs have been set to On-Off. This parameter is adjustable in range units within the range 0.1% to 10.0% of input span; the default value is 0.5% in units. The differential band is centred about the Setpoint.

Relay chatter can be eliminated by proper adjustment of this parameter. Too large a value for this parameter will increase amplitude of oscillation in this process variable.

Also refer to Input Range and Input Span and On-Off Control.

Heat or Cool Output Power Limit

Used to limit the power level of the Heat or Cool Outputs and may be used to protect the process being controlled. It may be adjusted between 0% and 100%. This parameter is not applicable if the primary output is set for On-Off control.

Also refer to On-Off Control.

Heat Proportional Band

The portion of the input span over which the Heat Output power level is proportional to the process variable value. It may be adjusted in range units equivalent to 0.5% to 999.9%, or ON.OFF of the input span.

Also refer to Control Type, On-Off Control, Input Span, Overlap/Deadband, PID, Cool Proportional Band, and Tuning.

High Calibration Point

This parameter is used to define the high calibration point when the two point calibration method is used to calibrate the controller.

Also refer to Two Point Calibration and High Offset.

High Offset

This parameter is used to define the high point offset value when the two point calibration method is used to calibrate the controller. This value is applied to the high calibration point.

Also refer to Two Point Calibration, High Calibration Point.

Input Filter Time Constant

This parameter is used to filter out extraneous impulses on the process variable. The filtered PV is used for all PV-dependent functions (display control, alarm etc). The time constant is adjustable from 0.0 seconds (off) to 100.0 seconds in 0.5 second increments.

Also refer to Process Variable.

Input Range and Input Span

The Input Range is the overall non-restricted range as determined by the **TYPE** parameter in the input sub-menu.

The Input Span (or Scaled Range) is the limited working range set by the upper and lower limits in the input sub-menu. The input span is used as the basis for calculations that relate to the span of the instrument (E.g. controller proportional bands).

Also refer to Scale Range Upper Limit and Scale Range Lower Limit

Integral Time

Refer to *Automatic Reset*.

Latching Relay

A type of relay that, once it becomes active, requires a reset signal before it will deactivate. This output is available on Limit controllers and indicator alarms. To successfully deactivate a latched relay, the alarm or limit condition that caused the relay to become active must first be removed, then a reset signal can be applied. This signal may be applied from the instrument keypad, or command via Serial Communication.

Also refer to Alarm Operation, Indicator, Limit Controller, Limit Hysteresis, Serial Communications.

Light Emitting Diode (LED)

A Light Emitting Diode or LED is used as an indicator light (e.g. for the alarm indication). The upper and lower 7-segment displays are formed from LEDs.

Limit Controller

A protective device that will shut down a process at a preset Exceed Condition, in order to prevent possible damage to equipment or products. They are recommended for any process that could potentially become hazardous under fault conditions.

Loop Alarm Enable

Enables or disables a loop alarm. A loop alarm is a special alarm, which detects faults in the control feedback loop, by continuously monitoring process variable response to the control output(s).

The loop alarm can be tied to any suitable output. When enabled, the loop alarm repeatedly checks if the control output(s) are at the maximum or minimum limit. If an output is at the limit, an internal timer is started: thereafter, if the high output has not caused the process variable to be corrected by a predetermined amount 'V' after time 'T' has elapsed, the loop alarm becomes active.

Subsequently, the loop alarm mode repeatedly checks the process variable and the control output(s). When the process variable starts to change value in the correct sense or when the output is no longer at the limit, the loop alarm is deactivated.

For PID control, the loop alarm time 'T' is always twice the Automatic Reset (Integral) parameter value.

For On-Off control, a user defined value for the Loop Alarm Time parameter is used.

The value of 'V' = 2°C or 3°F.

Control output limits are 0% for Single output (Heat only) controllers and -100% for Dual output (Heat and Cool) controllers.

Correct operation of the loop alarm depends upon reasonably accurate PID tuning. The loop alarm is automatically disabled during manual control mode and during execution of the Pre-Tune mode. Upon exit from manual mode or after completion of the Pre-Tune routine, the loop alarm is automatically re-enabled.

Also refer to Manual Mode, On-Off Control, Pre-Tune, and Process Variable.

Low Calibration Point

This parameter is used to define the low calibration point when the two point calibration method is used to calibrate the controller.

Also refer to Two Point Calibration, Low Offset.

Low Offset

This parameter is used to define the low point offset value when the two point calibration method is used to calibrate the controller. This value is applied to the low calibration point.

Also refer to Two Point Calibration, Low Calibration Point.

Milliamp DC (mADC)

It is used in reference to the DC milliamp input ranges. Typically, these will be 0 to 20mA or 4 to 20mA.

Manual Mode

If **MAN = On** selected then manual mode is selected. Switching between automatic and manual modes is achieved using bumpless transfer. Please refer to section User Mode.

Mode operates as follows:

The upper display shows the current process value, and the lower display shows the output power in the form - **P_{xxx}** (where xxx is equal to the percentage output power). This value may be adjusted using the **▲** or **▼** keys to increase/decrease the power output. The value can be varied between 0% to 100% for controllers using Heat control only, and -100% to +100% for controllers using Heat and Cool control (e.g. full heat power to full cool power).

Manual Mode should be used with care because the power output level is set by the operator, therefore the PID algorithm is no longer in control of the process. The operator **MUST** maintain the process as the desired level manually.

Manual power is not limited by the Heat and Cool Power Output Limit parameters.

Also refer to Bumpless Transfer, Manual Mode Enable, PID, and Heat Output Power Limit.

Master & Slave

The terms master & slave are used to describe the controllers in applications where one instrument controls the Setpoint of another. The master controller can transmit the Setpoint to the slave using an analogue DC linear signal or RS485. The slave controller must have a matching a remote Setpoint input. Some Profile Controllers can transmit their Setpoint via serial communications serial communications. For this method, the Profiler must be able to act as a communications master device and the slave must have a compatible communications option fitted. This controller can only be configured as a comms slave device

Also refer to Serial Communications and Setpoint

Offset / Single Point Calibration

Offset is used to modify the measured process variable value and is adjustable in the range \pm input span. Use this parameter to compensate for errors in the displayed process variable. Positive values are added to the process variable reading, negative values are subtracted. This parameter is in effect, a calibration adjustment; it **MUST** be used with care. Injudicious use could lead to the displayed value bearing no meaningful relationship to the actual process variable. There is no front panel indication of when this parameter is in use.

Also refer to Input Span, Process Variable and Tare.

On-Off Control

When operating in On-Off control, the output(s) will turn on or off as the process variable crosses the Setpoint in a manner similar to a central heating thermostat. Some oscillation of the process variable is inevitable when using On-Off control. On-Off control can be implemented by setting the corresponding proportional band(s) to On.OF. On-Off operation can be assigned to the Heat output alone (Cool output not present), Heat and Cool outputs or Cool output only (with the Heat Output set for time proportional).

Also refer to Differential, PID, Process Variable, Heat Proportional Band, Cool Proportional Band, Setpoint and Time Proportioning Control.

On-Off Differential (Hysteresis)

Refer to *Differential*.

Overlap/Deadband

Defines the portion of the Heat and Cool proportional bands over which both outputs are active (Overlap), or neither is active (Deadband). It is adjustable in the range -20% to +20% of the two proportional bands added together. Positive values = Overlap, negative values = Deadband.

This parameter is not applicable if the Heat output is set for On-Off control or there is no Cool Output. If the Cool Output is set for On-Off, this parameter has the effect of moving the Differential band of the Cool Output to create the overlap or deadband. When Overlap/Deadband = 0, the "OFF" edge of the Cool Output Differential band coincides with the point at which the Heat Output = 0%.

Also refer to *Differential, On-Off Control, Heat Proportional Band and Cool Proportional Band.*

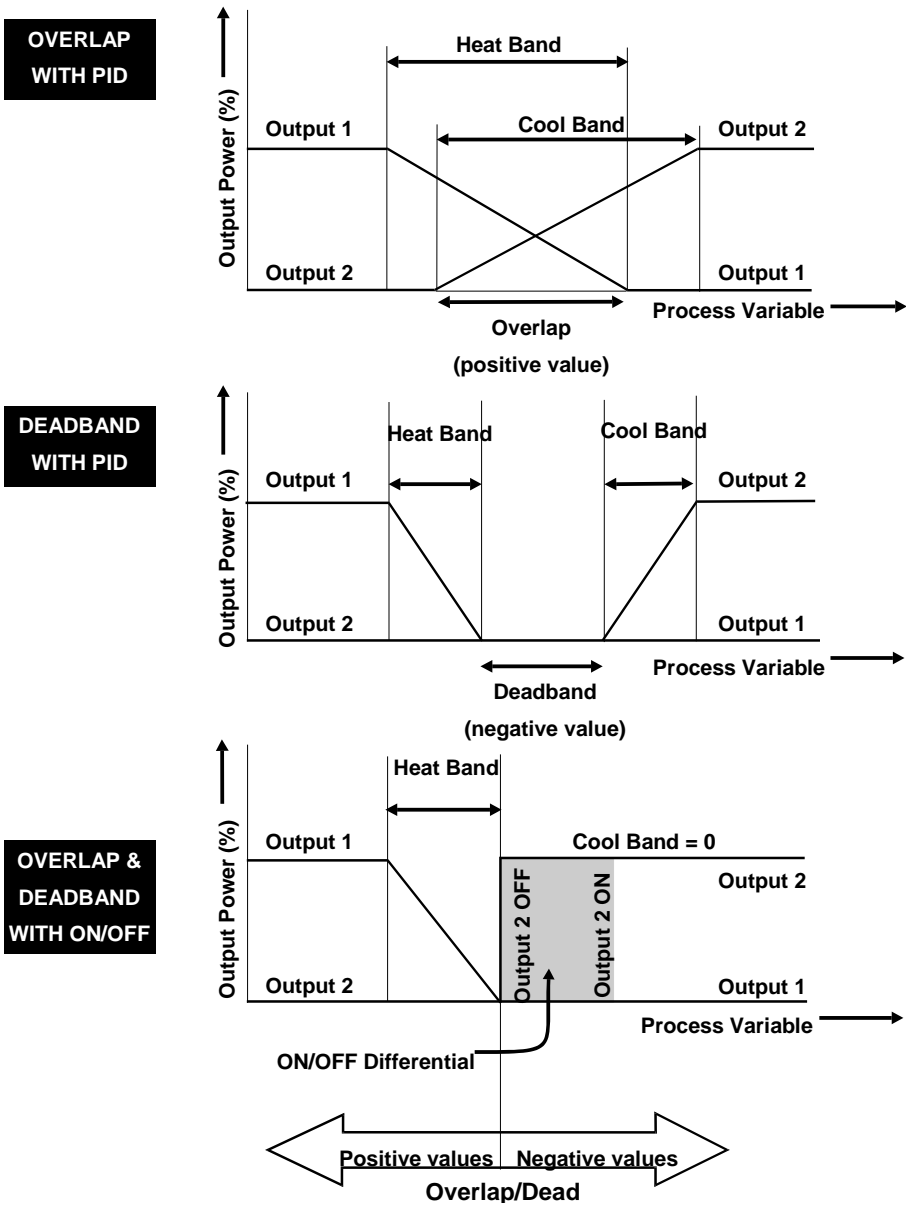

PID Control

Proportional Integral and Derivative control maintains accurate and stable levels in a process (e.g. temperature control). It avoids the oscillation characteristic of On-Off control by continuously adjusting the output to keep the process variable stable at the desired Setpoint.

Also refer to *Control Type, Automatic Reset, Controller, Manual Mode, On-Off Control, PI Control, Heat Proportional Band, Process Variable, Rate, Cool Proportional Band, Setpoint and Tuning*

Pre-Tune

The Pre-Tune facility artificially disturbs the start-up pattern so that a first approximation of the PID values can be made prior to the setpoint being reached. Starting with the load cool, tuning occurs during warm-up preventing overshoot. During Pre-Tune, the controller outputs full Heat Power until the process value has moved approximately halfway to the Setpoint. At that point, power is removed (or outputs full Cool Power), thereby introducing an oscillation. Once the oscillation peak has passed, the Pre-Tune algorithm calculates an approximation of the optimum PID tuning terms proportional band(s), automatic reset and rate.

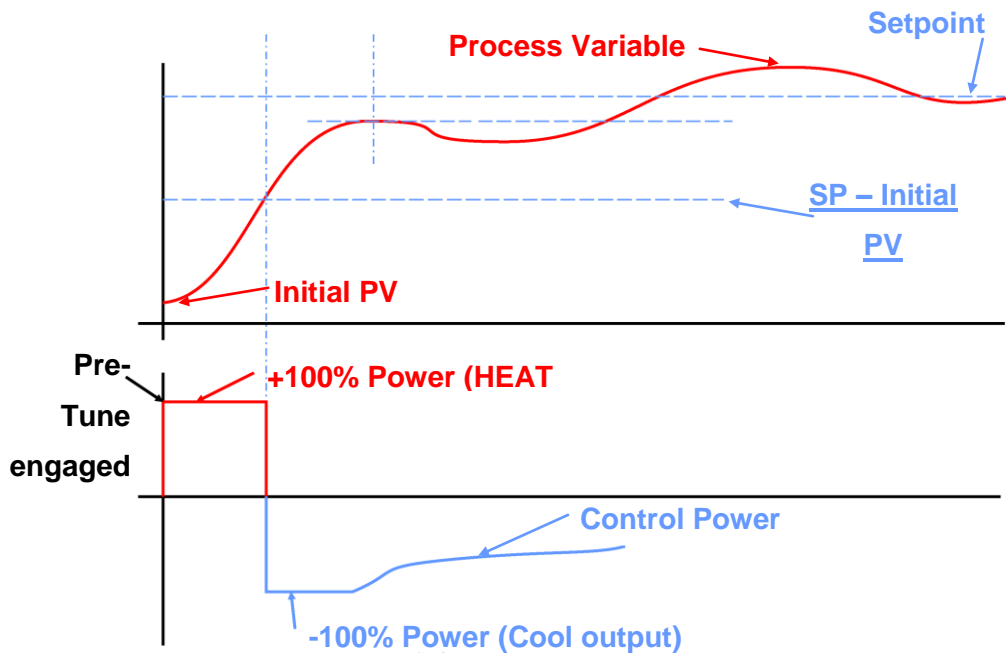

When Pre-Tune is completed, the PID control output power is applied using the calculated values. Pre-Tune limits the possibility of Setpoint overshoot when the controller is new or the application has been changed. It will automatically disengage once complete.

Ideally the Tune program should be used when the load temperature is at or near ambient. Care should be taken to ensure that any overshoot is safe for the process and if necessary tune at a lower setpoint.

Pre-Tune will not engage if either Heat or Cool outputs on a controller are set for On-Off control, the controller is set to Manual, during Setpoint ramping or if the process variable is less than 5% of the input span from the Setpoint.

Also refer to *Automatic Reset, Control Type, On-Off Control, Input Span, PID, Heat Proportional Band, Process Variable, Rate, Cool Proportional Band, Setpoint, Setpoint Ramping, Tune at Setpoint and Tuning*.

Process High Alarm Value

This parameter is applicable only when an Alarm is selected to be a Process High alarm. It defines the process variable value above which an Alarm will be active. Its value may be adjusted between Scale Range Upper Limit and Scale Range Lower Limit.

Also refer to Alarm Operation, Process Variable, Scale Range Lower Limit and Scale Range Upper Limit.

Process Low Alarm Value

This parameter is applicable only when an Alarm is selected to be a Process low alarm. It defines the process variable value below which an Alarm will be active. Its value may be adjusted between Scale Range Upper Limit and Scale Range Lower Limit.

Also refer to Alarm Operation, Process Variable, Scale Range Lower Limit and Scale Range Upper Limit.

Process Variable (PV)

Process Variable is the variable to be measured by the primary input of the instrument. The PV can be any parameter that can be converted into an electronic signal suitable for the input. Common types are Thermocouple or PT100 temperature probes, or pressure, level, flow etc from transducers which convert these parameters into linear DC signals (e.g. 4 to 20mA). Linear signals can be scaled into engineering units using the Scale Range Lower Limit and Scale Range Upper Limit parameters.
Also refer to Input Span, Offset, Scale Range Lower Limit and Scale Range Upper Limit.

Rate (Derivative)

Rate is adjustable in the range 0 seconds (OFF) to 99 minutes 59 seconds. It defines how the control action responds to the rate of change in the process variable. The Rate parameter is not available if Heat control output is set to On-Off.

Also refer to On-Off Control, PID, Process Variable and Tuning.

Reset / Integral

Refer to *Automatic Reset*.

Reverse Acting

- Refer to *Direct/Reverse Action of Control Output*

Scale Range Upper Limit

For linear inputs, this parameter is used to scale the process variable into engineering units. It defines the displayed value when the process variable input is at its maximum value. It is adjustable from -1999 to 9999 and can be set to a value less than (but not within 100 units of) the Scale Range Lower Limit, in which case the sense of the input is reversed.

For thermocouple and RTD inputs, this parameter is used to reduce the effective range of the input. All span related functions work from the trimmed input span. The parameter can be adjusted within the limits of the range selected by Configuration Mode parameter **TYPE**. It is adjustable to within 100 degrees of the Scale Range Lower Limit.

Also refer to Input Span, Process Variable and Scale Range Lower Limit.

Scale Range Lower Limit

For linear inputs, this parameter can be used to display the process variable in engineering units. It defines the displayed value when the process variable input is at its minimum value. It is adjustable from -1999 to 9999 and can be set to a value more than (but not within 100 units of) the Scale Range Upper Limit, in which case the sense of the input is reversed.

For thermocouple and RTD inputs, this parameter is used to reduce the effective range of the input. All span related functions, work from the trimmed span. The parameter can be adjusted within the limits of the range selected by parameter **TYPE**. It is adjustable to within 100 degrees of the Scale Range Upper Limit.

Also refer to Input Span, Process Variable and Scale Range Upper Limit.

Serial Communications Option

A feature that allows other devices such as PC's, PLC's or a master controller to read or change an instruments parameters via an RS485 Serial link.

Full details can be found in the Serial Communications sections of this manual.

Also refer to Controller, Indicator, Master & Slave and Limit Controller.

Setpoint

The target value at which a controller will attempt to maintain the process variable by adjusting its power output level. The value of the setpoints can be adjusted between the Setpoint Upper Limit and Setpoint Lower Limits.

Also refer to Limit Setpoint, Process Variable, Scale Range Lower Limit, Setpoint Lower Limit and Setpoint Upper Limit

Setpoint Upper Limit

The maximum limit allowed for operator Setpoint adjustments. It should be set to keep the Setpoint below a value that might cause damage to the process. The adjustment range is between Scale Range Upper Limit and Scale Range Lower Limit. The value cannot be moved below the current value of the Setpoint.

Also refer to Scale Range Lower Limit, Scale Range Upper Limit, Setpoint and Setpoint Lower Limit.

Setpoint Lower Limit

The minimum limit allowed for operator Setpoint adjustments. It should be set to keep the Setpoint above a value that might cause damage to the process. The adjustment range is between Scale Range Lower Limit and Scale Range Upper Limit. The value cannot be moved above the current value of the Setpoint.

Also refer to Scale Range Lower Limit, Scale Range Upper Limit, Setpoint and Setpoint Upper Limit.

Ramp Rate

The rate at which the actual Setpoint value will move towards its target value, when the Setpoint value is adjusted. With ramping in use, the initial value of the actual Setpoint at power up, or when switching back to automatic mode from manual control, will be equal to the current process variable value. The actual Setpoint will rise/fall at the ramp rate set, until it reaches the target Setpoint value. Setpoint ramping is used to protect the process from sudden changes in the Setpoint, which would result in a rapid rise in the process variable. If the setpoint is changed controller attempts to follow at the predefined ramp rate until the new setpoint is reach.

Also refer to Manual Mode, Setpoint, Setpoint Ramp Enable and Setpoint Select.

Solid State Relay (SSR)

An external device manufactured using two Silicone Controlled Rectifiers, which can be used to replace mechanical relays in most AC power applications. As a solid state device, an SSR does not suffer from contact degradation when switching electrical current. Much faster switching cycle times are also possible, leading to superior control. The instrument's SSR Driver output is a time proportioned 10Vdc pulse, which causes conduction of current to the load when the pulse is on.

Also refer to Cycle Time and Time Proportioning Control.

Solenoid Valve

An electromechanical device to control gas or liquid flow. It has just two states, open or closed. A spring holds the valve closed until a current is passed through the solenoid coil forces it open. Standard Process Controllers with Time Proportioned outputs are used to control solenoid valves.

Solenoid valves are often used with high/low flame gas burners. A bypass supplies some gas at all times, but not enough to heat the process more than a nominal amount (low flame). A controller output opens the solenoid valve when the process requires additional heat (high flame).

Also refer to Time Proportioning Control.

Time Proportioning Control

Time proportioning control is accomplished by cycling the output on and off, during the prescribed cycle time, whenever the process variable is within the proportional band. The control algorithm determines the ratio of time (on vs. off) to achieve the level of output power required to correct any error between the process value and Setpoint. E.g. for a 32 second cycle time, 25% power would result in the output turning on for 8 seconds, then off to 24 seconds. This type of output might be used with electrical contactors, Solid State Relays Time proportioning control can be implemented with Relay or SSR Driver outputs for either primary (Heat) or secondary (Cool) outputs depending on hardware configuration.

Also refer to Cycle Time, PID, Heat Proportional Band, Process Variable, Cool Proportional Band, Setpoint and SSR.

Tune at Setpoint

As parameters in the tuning process are directly related to the scaled input range, it is important to set **ScUL** and **ScLL** correctly, for your process, before running the tuning.

The Tune at Setpoint will not engage if the Heat or Cool outputs are set for **On-Off** control, the controller is set to Manual or during setpoint ramping.

The controller waits for the process to be in an approximate steady state for 5 minutes and if necessary attempts to further stabilise the process before continuing with the tuning.

At time, **T₀**, the controller makes a pulse of 20% change in the power output. It is reduced if the power value was >20% and increased if the power value was <20%.

When the process value changes by 1% of range, the output is returned to its previous value, **T₁**.

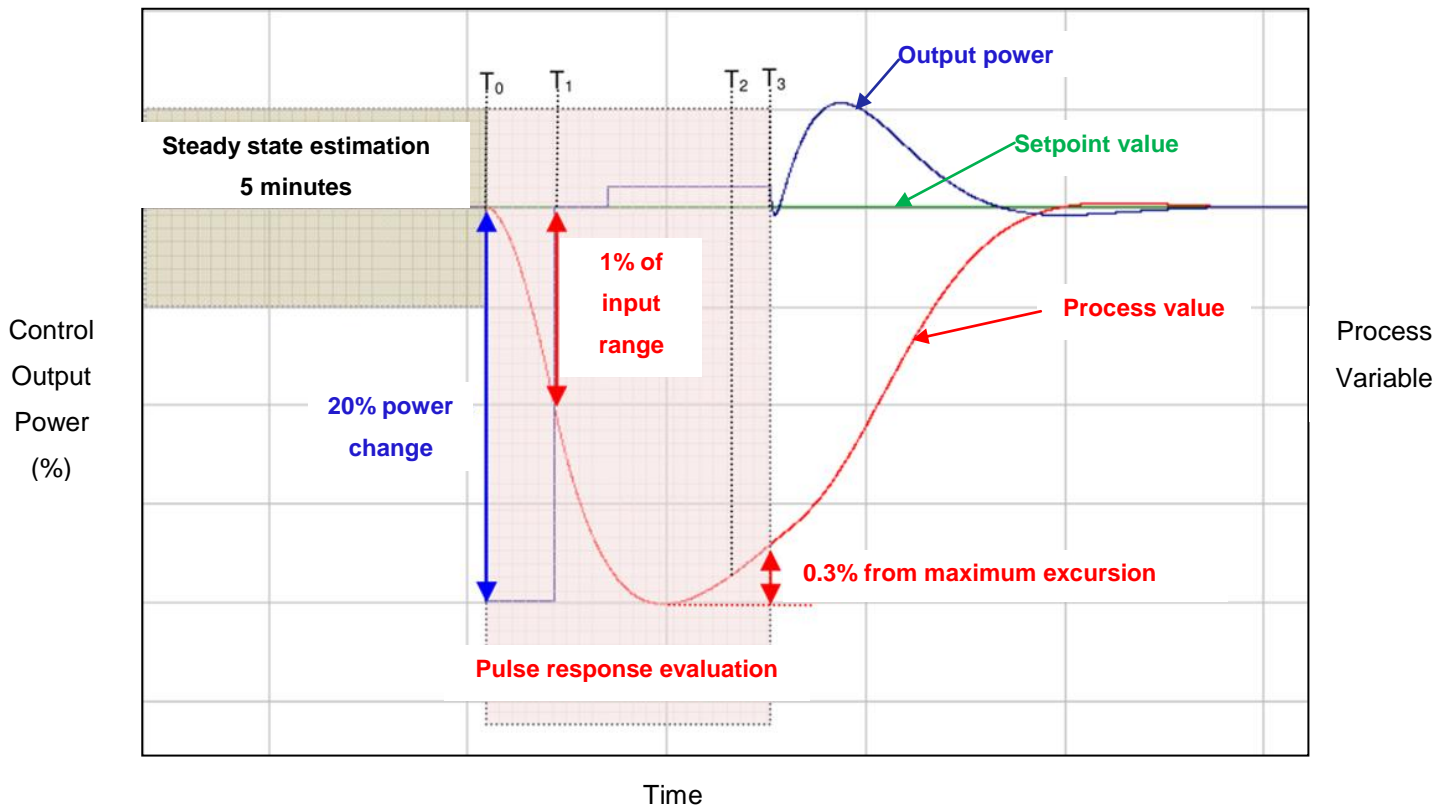

The process will reach a maximum excursion away from the setpoint and then return towards the setpoint. After a 0.3% recovery from maximum excursion, the pulse response characteristics are used to calculate the correct tuning terms.

Also refer to *Automatic Reset, Control Type, On-Off Control, Input Span, PID, Heat Proportional Band, Pre-Tune, Process Variable (PV), Rate, Cool Proportional Band, Setpoint, Setpoint Ramping and Tuning.*

Tuning PID

PID Controllers must be tuned to the process in order for them to attain the optimum level of control. Adjustment is made to the tuning terms either manually, or by utilising the controller's automatic tuning facilities. Tuning is not required if the controller is configured for On-Off Control.

Also refer to Automatic Reset, ON-OFF control, PID, Pre-Tune, Heat Proportional Band, Rate and Cool Proportional Band.

16 Product Code

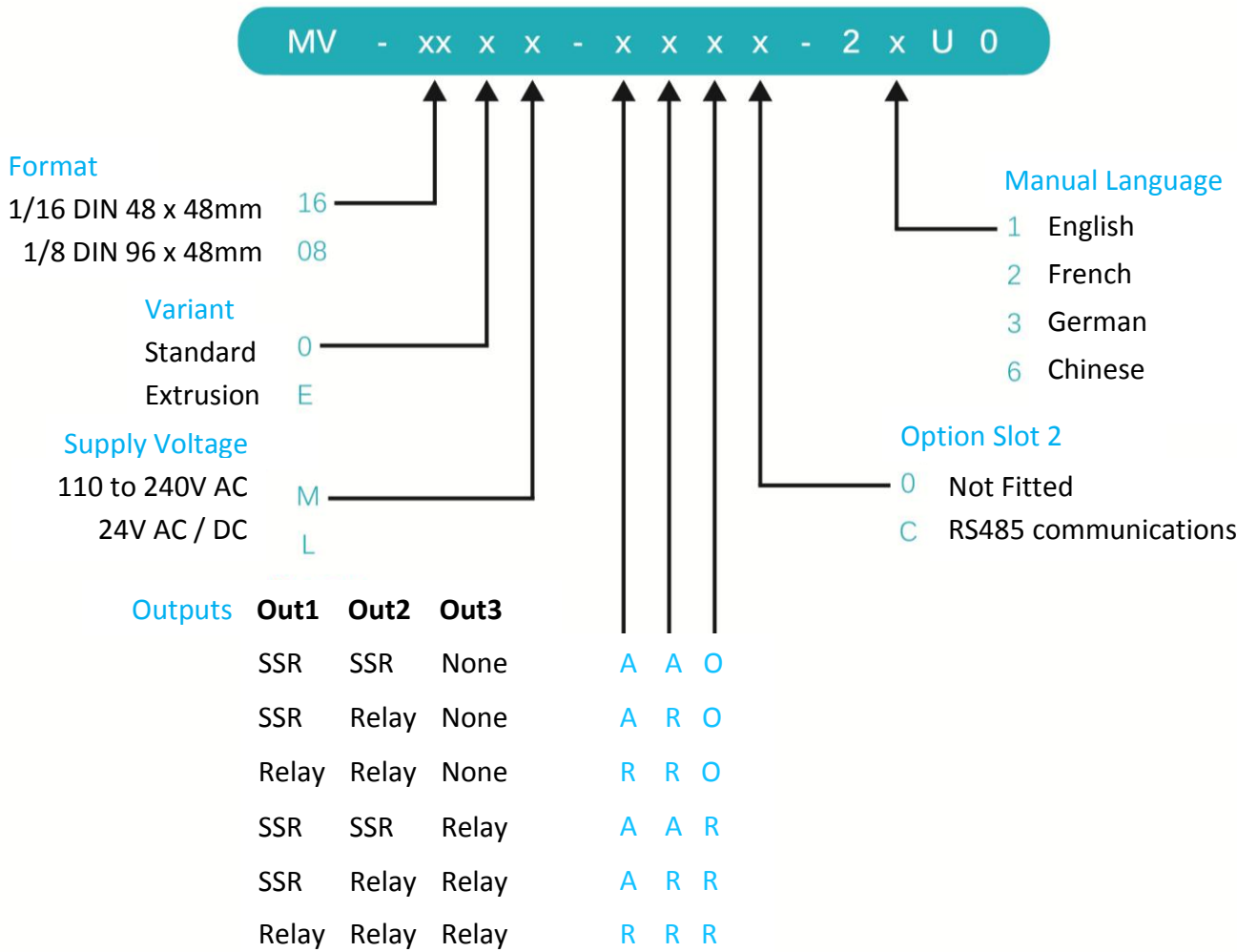



WEST Control Solutions — your global partner for temperature and process control



WEST  **Partlow**
